



SERVICE MANUAL

VHF TRANSCEIVER

IC-F110
IC-F111
IC-F121

INTRODUCTION

This service manual describes the latest service information for the **IC-F110, F111 and F121** VHF TRANSCEIVER at the time of publication.

MODEL	VERSION	SYMBOL
IC-F110	Europe	EUR
	General	GEN
IC-F111	General	GEN
IC-F121	U.S.A.	USA

To upgrade quality, any electrical or mechanical parts and internal circuits are subject to change without notice or obligation.

DANGER

NEVER connect the transceiver to an AC outlet or to a DC power supply that uses more than 16 V. This will ruin the transceiver.

DO NOT expose the transceiver to rain, snow or any liquids.

DO NOT reverse the polarities of the power supply when connecting the transceiver.

DO NOT apply an RF signal of more than 20 dBm (100 mW) to the antenna connector. This could damage the transceiver's front end.



ORDERING PARTS

Be sure to include the following four points when ordering replacement parts:

1. 10-digit order numbers
2. Component part number and name
3. Equipment model name and unit name
4. Quantity required

<SAMPLE ORDER>

1110003490 S.IC TA31136FN IC-F110 MAIN UNIT 5 pieces
8810009990 Screw PH BT M3x8 ZKIC-F110 Bottom cover 10 pieces

Addresses are provided on the inside back cover for your convenience.

REPAIR NOTES

1. Make sure a problem is internal before disassembling the transceiver.
2. **DO NOT** open the transceiver until the transceiver is disconnected from its power source.
3. **DO NOT** force any of the variable components. Turn them slowly and smoothly.
4. **DO NOT** short any circuits or electronic parts. An insulated tuning tool **MUST** be used for all adjustments.
5. **DO NOT** keep power ON for a long time when the transceiver is defective.
6. **DO NOT** transmit power into a signal generator or a sweep generator.
7. **ALWAYS** connect a 40 dB to 50 dB attenuator between the transceiver and a deviation meter or spectrum analyzer when using such test equipment.
8. **READ** the instructions of test equipment thoroughly before connecting equipment to the transceiver.

EXPLICIT DEFINITIONS

FREQUENCY COVERAGE

136 – 174 MHz

CHANNEL SPACING

Narrow/Wide-type	12.5 kHz/ 25.0 kHz
	15.0 kHz/ 30.0 kHz
Narrow/Middle-type	12.5 kHz/ 20.0 kHz

TABLE OF CONTENTS

SECTION 1	SPECIFICATIONS	
SECTION 2	INSIDE VIEW	
SECTION 3	DISASSEMBLY INSTRUCTIONS	
SECTION 4	CIRCUIT DESCRIPTION	
4 - 1	RECEIVER CIRCUITS	4 - 1
4 - 2	TRANSMITTER CIRCUITS	4 - 2
4 - 3	PLL CIRCUITS	4 - 3
4 - 4	POWER SUPPLY CIRCUITS	4 - 4
4 - 5	PORT ALLOCATIONS	4 - 4
SECTION 5	ADJUSTMENT PROCEDURES	
5 - 1	PREPARATION	5 - 1
5 - 2	PLL ADJUSTMENT	5 - 4
5 - 3	SOFTWARE ADJUSTMENT	5 - 5
SECTION 6	PARTS LIST	
SECTION 7	MECHANICAL PARTS AND DISASSEMBLY	
SECTION 8	SEMI-CONDUCTOR INFORMATION	
SECTION 9	BOARD LAYOUTS	
9 - 1	FRONT UNIT	9 - 1
9 - 2	MAIN UNIT	9 - 3
SECTION 10	BLOCK DIAGRAM	
SECTION 11	VOLTAGE DIAGRAMS	
11 - 1	FRONT UNIT	11 - 1
11 - 2	MAIN UNIT	11 - 2

SECTION 1 SPECIFICATIONS

		[GEN], [USA]	[EUR]
GENERAL	Measurement method	EIA-152-C/204D or TIA-603	ETS 300 086
	Frequency coverage	136.000–174.000 MHz	
	Type of emission	N/W: (12.5 kHz; Narrow/25 kHz; Wide): 8K50F3E/16K0F3E (12.5 kHz; Narrow/25 kHz; Wide): 11K0F3E/16K0F3E (15 kHz; Narrow/30 kHz; Wide): 11K0F3E/16K0F3E N/M (12.5 kHz; Narrow/20 kHz; Middle): 8K50F3E/14K0F3E	[EUR] [GEN] [USA] [EUR]
	Number of conventional channels	maximum 128 channels	
	Antenna impedance	50 Ω nominal (SO-239)	
	Power supply voltage (negative ground)	13.6 V DC nominal	13.2 V DC nominal
	Current drain (approx.)	TX; 7.0 A (at 25 W), 14.0 A (at 50 W) Rx; 1200 mA (maximum audio) 300 mA (stand-by)	
	Usable temperature range	–30°C to +60°C (–22°F to +140°F)	–25°C to +55°C
	Dimensions (proj. not included)	150(W) × 40(H) × 117.5(D) mm; 5 ²⁹ / ₃₂ (W) × 4 ⁹ / ₁₆ (H) × 4 ⁵ / ₈ (D) inch 150(W) × 40(H) × 167.5(D) mm; 5 ²⁹ / ₃₂ (W) × 4 ⁹ / ₁₆ (H) × 6 ¹⁹ / ₃₂ (D) inch	[25 W] [50 W]
	Weight	0.8 kg; 1 lb 12 oz [25 W], 1.1 kg; 2 lb 7 oz [50 W]	
TRANSMITTER	RF output power	High/Low2/Low1: 25 W/10 W/2.5 W [25 W] High/Low2/Low1: 50 W/25 W/5 W [50 W]	
	Modulation system	Variable reactance frequency modulation	
	Maximum permissible deviation	±2.5 kHz [Narrow], ±4.0 kHz [Middle], ±5.0 kHz [Wide]	
	Frequency error	±5.0 ppm	±1.5 kHz
	Spurious emissions	70 dB (typical)	0.25 μW ≤ 1GHz, 1.0 μW > 1 GHz
	Adjacent channel power	60 dB minimum [Narrow]; 70 dB minimum [Middle], [Wide]	
	Audio frequency response	+2 dB to –5 dB of 6 dB/octave Range from 300 Hz to 2550 Hz [Narrow] / 3000 Hz [Middle], [Wide]	
	Audio harmonic distortion	3% typical at 1 kHz (40% deviation)	
	FM hum and noise (typical) (without CCICT filter)	34 dB (min.), 40 dB (typ.) [Narrow] 40 dB (min.), 46 dB (typ.) [Wide]	—
	Residual modulation (typical) (with CCICT filter)	—	40 dB (min.), 50 dB (typ.) [Narrow] 43 dB (min.), 53 dB (typ.) [Middle] 45 dB (min.), 55 dB (typ.) [Wide]
	Limiting charact of modulator	70 – 100% of maximum deviation	
	Microphone connector	8-pin modular (600 Ω)	
RECEIVER	Receive system	Double-conversion superheterodyne system	
	Intermediate frequencies	1st: 46.35 MHz, 2nd: 450 kHz	
	Sensitivity (typical)	0.25 μV typical at 12 dB SINAD	–4 dBμV (emf) typical at 20 dB SINAD
	Squelch sensitivity (at threshold)	0.25 μV typical	–4 dBμV (emf) typical
	Hum and noise	34 dB (min.), 40 dB (typ.) [Narrow] 40 dB (min.), 45 dB (typ.) [Wide]	40 dB (min.), 50 dB (typ.) [Narrow] 43 dB (min.), 53 dB (typ.) [Middle] 45 dB (min.), 55 dB (typ.) [Wide]
	Adjcent channel selectivity	60 dB (min.), 65 dB (typ.) 70 dB (min.), 75 dB (typ.)	[Narrow] [Middle]/[Wide]
	Spurious response	75 dB	
	Intermoduration	70 dB (min.), 74 dB (typ.)	65 dB (min.), 67 dB (typ.)
	Audio output power	4 W typical at 10% distortion with a 4 Ω load	
	External SP connector	2-conductor 3.5 (d) mm (1/8")/4 Ω	

All stated specifications are subject to change without notice or obligation.

SECTION 2 INSIDE VIEW

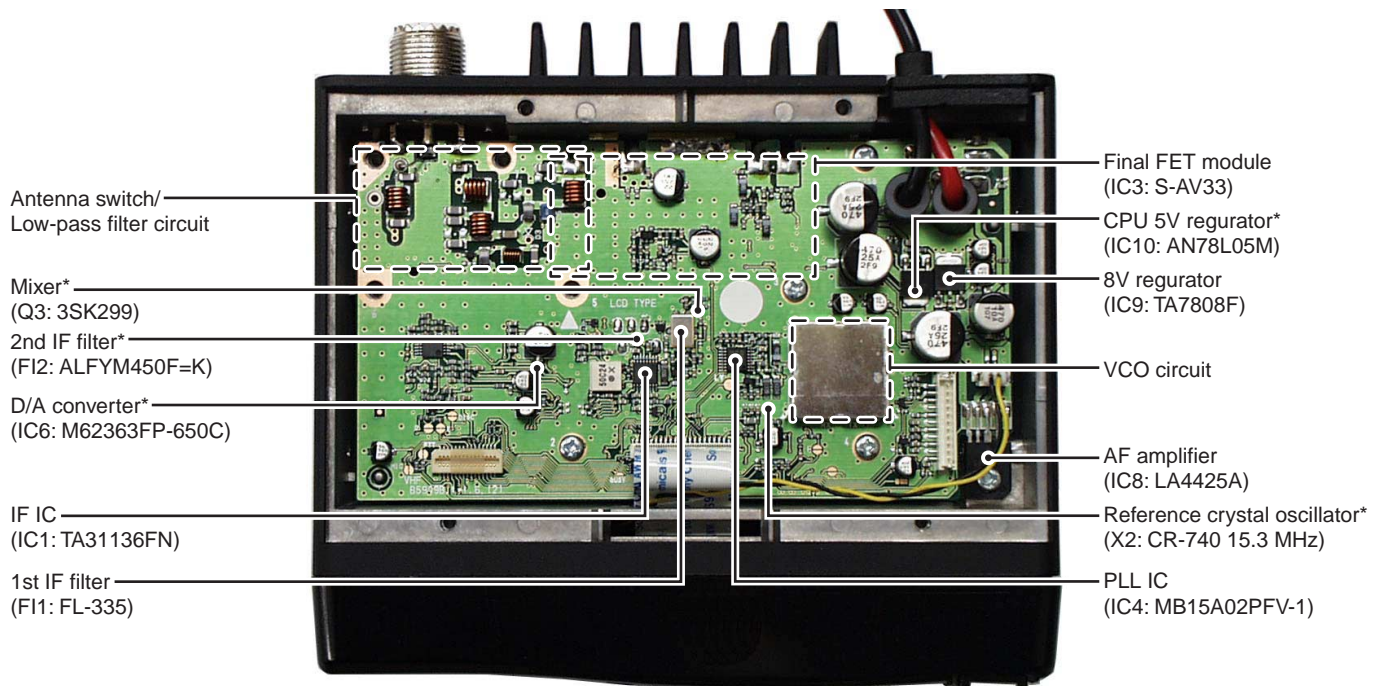

* Located under side of the point.

SECTION 3 DISASSEMBLY INSTRUCTIONS

• Opening case

- ① Unscrew 4 screws (A), and remove the bottom cover.
- ② Disconnect the flat cable (B) from J2.
- ③ Disconnect the cable (C) from J7.
- ④ Unscrew 2 screws (D), and remove the front unit.

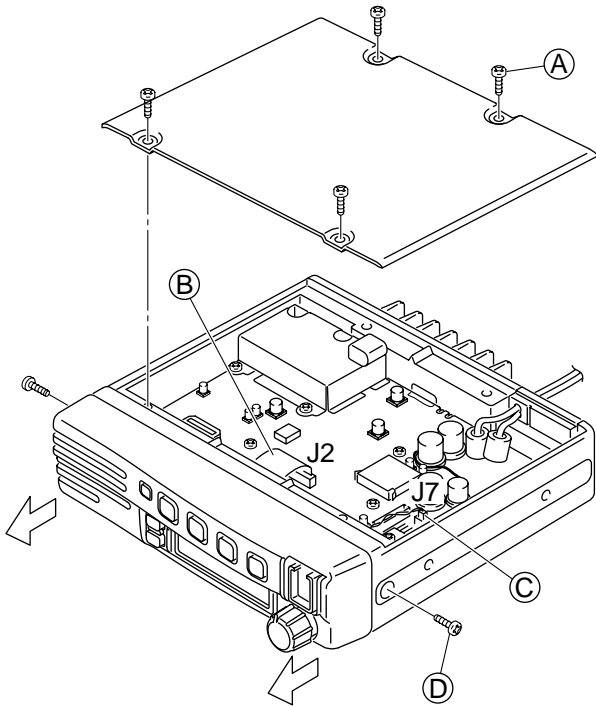

- ⑤ Unscrew 8 screws (E).
- ⑥ Remove the filter case (F).
- ⑦ Unscrew the screw (G).
- ⑧ Unsolder 3 points (H) from the antenna connector.
- ⑨ Unsolder 4 points (I) from IC3.

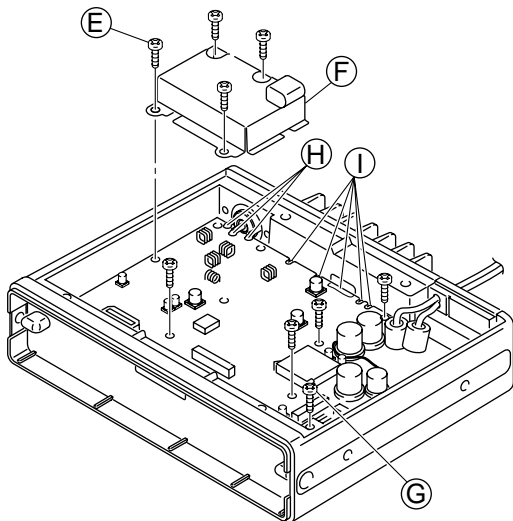

- ⑩ Lift up the front portion of the main unit and remove it.

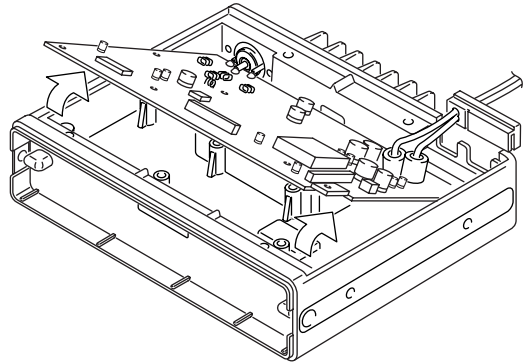

• Installation location

UT-105	SmarTrank 2™ logic board
UT-108	DTMF decoder unit
UT-109	Voice scrambler unit
UT-110	
UT-111	Trunking unit
OPC-617	ACC cable (for external terminal connection)

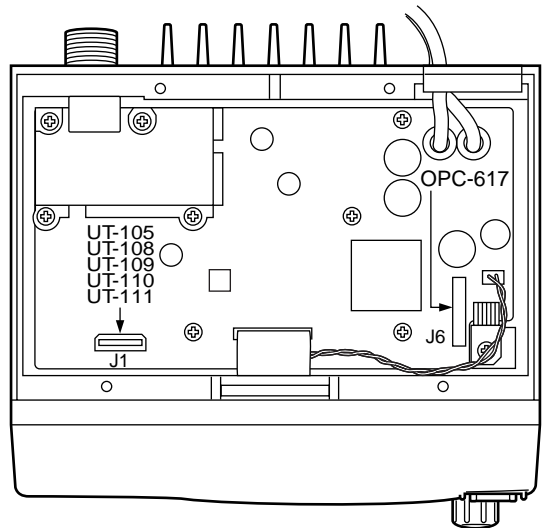

SECTION 4 CIRCUIT DESCRIPTION

4-1 RECEIVER CIRCUITS

4-1-1 ANTENNA SWITCHING CIRCUIT (MAIN UNIT)

The antenna switching circuit functions as a low-pass filter while receiving and as resonator circuit while transmitting. This circuit does not allow transmit signals to enter the receiver circuits.

Received signals enter the antenna connector and pass through the low-pass filters (L1–L3, C1, C2, C6–8). The filtered signals are then applied to the RF circuit passed through the $\lambda/4$ type antenna switching circuit (D5–D7, D48, L4, L6).

4-1-2 RF CIRCUIT (MAIN UNIT)

The RF circuit amplifies signals within the range of frequency coverage and filters out-of-band signals.

The signals from the antenna switching circuit pass through the two-stage tunable bandpass filters (D8, D4). The filtered signals are amplified at the RF amplifier (Q2) and then enter other two-stage bandpass filters (D9, D10) to suppress unwanted signals. The filtered signals are applied to the 1st mixer circuit (Q3).

The tunable bandpass filters (D4, D8–D10) employ varactor diodes to tune the center frequency of the RF passband for wide bandwidth receiving and good image rejection. These diodes are controlled by the CPU (FRONT unit; IC1) via the D/A converter (IC6).

The gate control circuit reduces RF amplifier gain and attenuates RF signal to keep the audio output at a constant level.

The receiver gain is determined by the voltage on the "RSSI" line from the FM IF IC (IC1, pin 12). The gate control circuit (Q1) supplies control voltage to the RF amplifier (Q2) and sets the receiver gain.

When receiving strong signals, the "RSSI" voltage increases and the gate control voltage decreases. As the gate control voltage is used for the bias voltage of the RF amplifier (Q2), then the RF amplifier gain is decreased.

• 2ND IF AND DEMODULATOR CIRCUIT

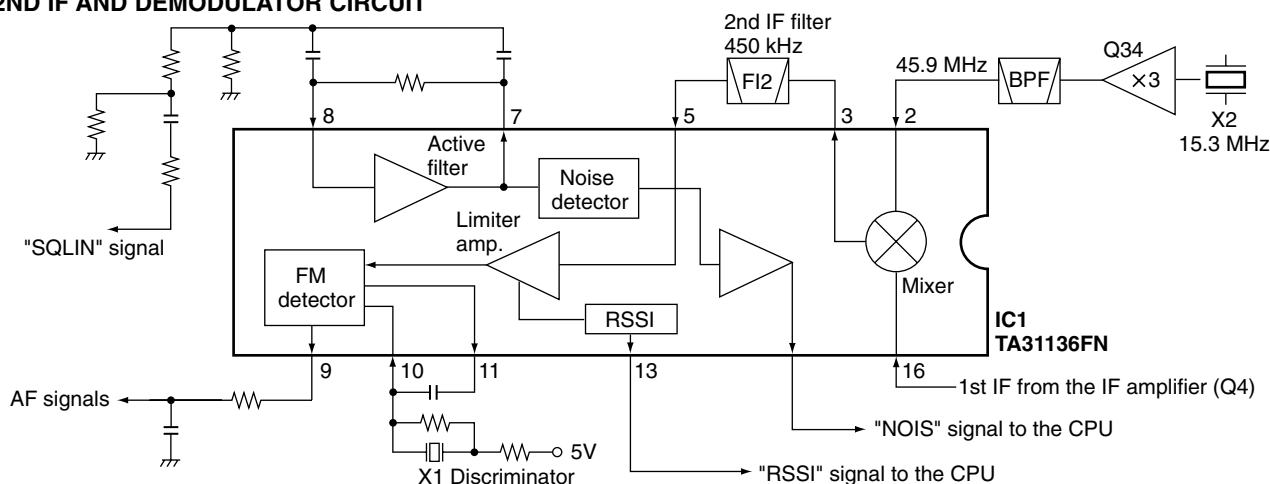

4-1-3 1ST MIXER AND 1ST IF CIRCUITS (MAIN UNIT)

The 1st mixer circuit converts the received signals to a fixed frequency of the 1st IF signal with the PLL output frequency. By changing the PLL frequency, only the desired frequency will pass through a MCF (Monolithic Crystal Filter; F11) at the next stage of the 1st mixer.

The RF signals from the bandpass filter are applied to the 1st mixer circuit (Q3). The applied signals are mixed with the 1st LO signal coming from the RX VCO circuit (Q14) to produce a 46.35 MHz 1st IF signal. The 1st IF signal passes through a MCF (Monolithic Crystal Filter; F11) to suppress out-of-band signals. The filtered signal is amplified at the 1st IF amplifier (Q4) and applied to the 2nd IF circuit.

4-1-4 2ND IF AND DEMODULATOR CIRCUITS (MAIN UNIT)

The 2nd mixer circuit converts the 1st IF signal to a 2nd IF signal. A double-conversion superheterodyne system improves the image rejection ratio and obtains stable receiver gain.

The 1st IF signal from the 1st IF amplifier (Q4) is applied to the 2nd mixer section of the FM IF IC (IC1, pin 16) and is then mixed with the 2nd LO signal for conversion to a 450 kHz 2nd IF signal.

IC1 contains the 2nd mixer, limiter amplifier, quadrature detector, active filter and noise amplifier circuits, etc. A tripled frequency from the PLL reference oscillator is used for the 2nd LO signal (45.9 MHz).

The 2nd IF signal from the 2nd mixer (IC1, pin 3) passes through a ceramic filter (F12) to remove unwanted heterodyned frequencies. It is then amplified at the limiter amplifier section (IC1, pin 5) and applied to the quadrature detector section (IC1, pins 10, 11 and X1) to demodulate the 2nd IF signal into AF signals.

The AF signals are output from pin 9 (IC1) and are then applied to the AF amplifier circuit.

4-1-5 AF AMPLIFIER CIRCUIT (MAIN UNIT)

The AF amplifier circuit amplifies the demodulated AF signals to drive a speaker.

The AF signals from the FM IF IC (IC1, pin 9) are applied to the active filter circuit (IC16). The active filter circuit (high-pass filter) removes CTCSS or DTCS signals.

The filtered AF signals are output from pin 14 (IC16) and are applied to the de-emphasis circuit (R117, C378) with frequency characteristics of -6 dB/octave, and then passed through the analog switch (IC14, pins 1–3) and low-pass filter (IC5). The filtered signal is applied to the electronic volume controller (IC6, pin 9).

The output AF signals from the electronic volume controller (IC6, pin 10) are passed through the analog switch (IC14 pins 9–11) and are applied to the AF amplifier (IC15) and AF power amplifier (IC8) to drive the speaker.

4-1-6 RECEIVER MUTE CIRCUITS (MAIN AND FRONT UNITS)

• NOISE SQUELCH

The noise squelch circuit cuts out AF signals when no RF signals are received. By detecting noise components in the AF signals, the squelch circuit switches the AF mute switch.

Some noise components in the AF signals from the FM IF IC (IC1, pin 9) are passed through the level controller (IC6, pins 1, 2). The level controlled signals are applied to the active filter section in the FM IF IC (IC1, pin 8). Noise components about 10 kHz are amplified and output from pin 7.

The filtered signals are converted to the pulse-type signals at the noise detector section and output from pin 13 (NOIS).

The NOIS signal from the FM IF IC is applied to the CPU (FRONT unit; IC1, pin 53). The CPU then analyzes the noise condition and controls the AF mute signal via "AFON" line (D44, D45) to the AF mute circuit (Q35, Q36, D29, D30).

• CTCSS AND DTCS

The tone squelch circuit detects AF signals and opens the squelch only when receiving a signal containing a matching subaudible tone (CTCSS or DTCS). When tone squelch is in use, and a signal with a mismatched or no subaudible tone is received, the tone squelch circuit mutes the AF signals even when noise squelch is open.

A portion of the AF signals from the FM IF IC (IC1, pin 9) passes through the low-pass filter (IC16) to remove AF (voice) signals and is applied to the CTCSS or DTCS decoder inside the CPU (FRONT unit; IC1, pin 60) via the "CDEC" line to control the AF mute switch.

4-2 TRANSMITTER CIRCUITS

4-2-1 MICROPHONE AMPLIFIER CIRCUIT (MAIN AND FRONT UNITS)

The microphone amplifier circuit amplifies audio signals within $+6$ dB/octave pre-emphasis characteristics from the microphone to a level needed for the modulation circuit.

The AF signals (MIC) from the MIC jack (FRONT unit; J1) are amplified at the AF amplifier (FRONT unit; IC5) and applied to the MAIN unit via J2 (pin 28). The AF signal are applied to the limiter amplifier (IC5, pin 5).

The entered signals are pre-emphasized with $+6$ dB/octave at a limiter amplifier, then passed through the analog switch (IC14, pins 2–4) and splatter filter (IC5, pins 2, 1). The output signals from the splatter filter are applied to the level controller (IC6, pin 9).

The deviation level controlled signals are then applied to the modulation circuit (D18) as the "MOD" signal after being passed through the analog switch (IC14, pins 9, 8).

4-2-2 MODULATION CIRCUIT (MAIN AND FRONT UNITS)

The modulation circuit modulates the VCO oscillating signal (RF signal) using the microphone audio signals.

The AF signals from the analog switch (IC14, pin 8) change the reactance of varactor diode (D18) to modulate the oscillated signal at the TX VCO circuit (Q13, D16, D31). The modulated VCO signal is amplified at the buffer amplifiers (Q11, Q10) and is then applied to the drive amplifier circuit via the T/R switch (D14).

The CTCSS/DTCS signals from the CPU (FRONT unit; IC1, pins 22–24) are passed through the low-pass filter (FRONT unit; IC5), and mixer and splatter filter (IC5), and are then applied to the VCO circuit.

4-2-3 DRIVE AMPLIFIER CIRCUIT (MAIN UNIT)

The drive amplifier circuit amplifies the VCO oscillating signal to the level needed at the power amplifier.

The RF signal from the buffer amplifier (Q10) passes through the T/R switch (D14) and is amplified at the drive amplifier circuit (Q8). The amplified signal is applied to the power amplifier circuit.

4-2-4 POWER AMPLIFIER CIRCUIT (MAIN UNIT)

The power amplifier circuit amplifies the driver signal to an output power level.

The RF signal from the drive amplifier (Q8) is passed through the low-pass filter circuit (L18, L43, C89, C90, C92, C380, C381, C510) and applied to the power module (IC3) to obtain 25 W or 50 W of RF power.

The amplified signal is passed through the antenna switching circuit (D2), low-pass filter and APC detector, and is then applied to the antenna connector.

Control voltage for the power amplifier (IC3, pin 2) comes from the APC amplifier (IC2) to stabilize the output power. The transmit mute switch (D28) controls the APC amplifier when transmit mute is necessary.

4-2-5 APC CIRCUIT (MAIN UNIT)

The APC circuit protects the power amplifier from a mismatched output load and stabilizes the output power.

The APC detector circuit detects forward signals and reflection signals at D1 and D11 respectively. The combined voltage is at minimum level when the antenna impedance is matched at 50 Ω , and is increased when it is mismatched.

The detected voltage is applied to the APC amplifier (IC2, pin 3), and the power setting "T2" signal from the D/A converter (IC6, pin 22), controlled by the CPU (FRONT unit; IC1), is applied to the other input for reference. When antenna impedance is mismatched, the detected voltage exceeds the power setting voltage. Then the output voltage of the APC amplifier (IC2, pin 4) controls the input current of the drive amplifier (Q8) and power module (IC3) to reduce the output power.

4-3 PLL CIRCUITS

4-3-1 PLL CIRCUIT (MAIN UNIT)

A PLL circuit provides stable oscillation of the transmit frequency and receive 1st LO frequency. The PLL output compares the phase of the divided VCO frequency to the reference frequency. The PLL output frequency is controlled by the divided ratio (N-data) of a programmable divider.

The PLL circuit contains the TX/RX VCO circuit (Q13, Q14). The oscillated signal is amplified at the buffer amplifiers (Q11, Q12) and then applied to the PLL IC (IC4, pin 8) via the low-pass filter (L32, C298–C300).

The PLL IC contains a prescaler, programmable counter, programmable divider and phase detector, etc. The entered signal is divided at the prescaler and programmable counter section by the N-data ratio from the CPU. The reference signal is generated at the reference oscillator (X2) and is also applied to the PLL IC. The PLL IC detects the out-of-step phase using the reference frequency, and outputs it from pin 5. The output signal is passed through the loop filter (R97/C149, R96/C147), and is then applied to the VCO circuit as the lock voltage.

If the oscillated signal drifts, its phase changes from that of the reference frequency, causing a lock voltage change to compensate for the drift in the oscillated frequency.

4-3-2 VCO CIRCUIT (MAIN UNIT)

The VCO circuit contains a separate RX VCO (Q14, D33, D34) and TX VCO (Q13, D16, D18, D31). The oscillated signal is amplified at the buffer amplifiers (Q11, Q10) and is then applied to the T/R switch circuit (D14, D15). Then the receive 1st LO (Rx) signal is applied to the 1st mixer (Q3) and the transmit (Tx) signal to the drive amplifier circuit (Q8).

A portion of the signal from the buffer amplifier (Q11) is fed back to the PLL IC (IC4, pin 8) via the buffer amplifier (Q12) and low-pass filter (L32, C298–C300) as the comparison signal.

• PLL CIRCUIT

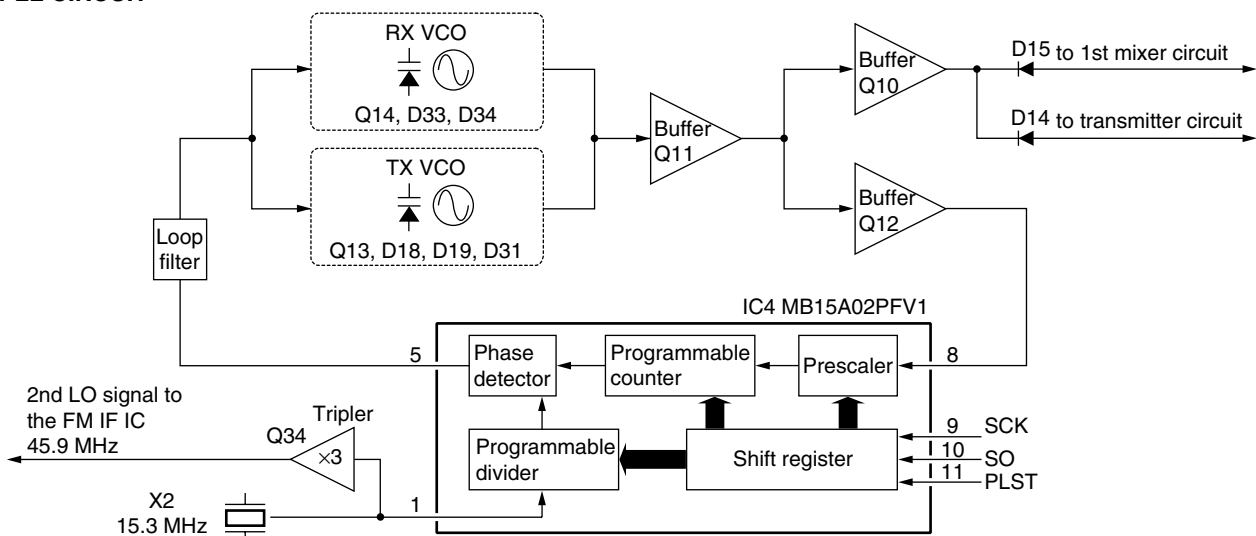

4-4 POWER SUPPLY CIRCUITS

4-4-1 VOLTAGE LINES (MAIN UNIT)

Line	Description
HV	The voltage from a DC power supply.
VCC	The same voltage as the HV line which is controlled by the power switching circuit (Q23, Q24). When the [POWER] switch is pushed, the CPU outputs the "PWON" control signal to the power switching circuit to turn the circuit ON.
CPU5V	Common 5 V for the CPU converted from the HV line by the CPU5V regulator circuit (IC10). The circuit outputs the voltage regardless of the power ON/OFF condition.
8V	Common 8 V converted from the VCC line by the 8V regulator circuit (IC9).
5V	Common 5 V converted from the 8 V and CPU5V lines by the 5V regulator circuit (Q27, Q28).
R8V	Receive 8 V controlled by the R8 regulator circuit (Q26, Q30) using the "RXC" signal from the expander IC (IC17, pin 4).
T8V	Transmit 8 V controlled by the T8 regulator circuit (Q25, Q29, D23) using the "TMUT" signal from the expander IC (IC17, pin 13).

4-5 PORT ALLOCATIONS

4-5-1 CPU (FRONT UNIT; IC1)

Pin number	Port name	Description
1	TEMP	Input port for the internal temperature.
2	BATV	Input port for the low voltage detection from the connected power supply.
7	RES	Input port for reset signal.
13-14	SENC0-SENC1	Output ports for 5/2 tone and DTMF signals.
15	CSFT	Outputs the CPU clock shift signal.
16	DUSE	Outputs cut-off frequency control signal to the low-pass filter (MAIN unit; IC5) for CTCSS/DTCS switching.
17, 18	KS0, KS1	Input port for the key matrix.
19-20	SENC2-SENC3	Output ports for 5/2 tone and DTMF signals.
21	UNLK	Input port for the PLL unlock signal from the PLL IC (MAIN unit; IC4).
22	KR0	Input port for the key matrix.
23-25	CENO0-CENO2	Output ports for CTCSS/DTCS signals.
26, 27	KR1, KR2	Input ports for the key matrix.
28	SCK	Outputs the clock signal to the PLL IC (MAIN unit; IC4), D/A converter (MAIN unit; IC6), LED driver (IC4) and optional board (connect to MAIN unit; J1).
29	SO	Outputs the data signal to the PLL IC (MAIN unit; IC4), D/A converter (MAIN unit; IC6) and optional board (connect to MAIN unit; J1).
30	BEEP	Output port for beep sound signal.
31	ESDA	I/O port for the data signal for the EEPROM (IC3)
32	ESCL	Outputs the clock signal for the EEPROM (IC3).
33	LSCK	Outputs the clock signal for the LCD driver (IC6, pin 17).
34	LSO	Outputs the data signal for the LCD driver (IC6, pin 48).
36	PLST	Outputs the strobe signal for the PLL IC (MAIN unit; IC4).
37	DAST	Outputs the strobe signal for the D/A converter IC (MAIN unit; IC6).
38	EXST	Outputs the strobe signal for the expander IC (IC17).
39	EXOE	Outputs the control signal for the LCD driver IC (IC6).
41	PWON	Outputs the control signal for the power switching circuit (MAIN unit; Q24, Q23).

CPU-Continued

Pin number	Port name	Description
44–46	OPT3–OPT1	I/O ports for the optional board control signals.
48	SI	Input port for the clock signal from the optional board via J1.
49	CLI	Input port for the cloning signal.
50	CLO	Output port for the cloning signal.
51	POSW	Input port for the POWER switch.
52	IGSW	<ul style="list-style-type: none"> • Input port for the remote power control signal from the external connector.(J6) • Input port for the dimmer control.
83	NOIS	Input port for the “NOIS” signal from the FM IF IC (MAIN unit; IC1) for noise squelch operation.
54	CIRQ	Input port for interruption signal from the optional board via J1.
55	CCS	Outputs chip select signal for the optional board via J1.
56	PTT	Input port for the PTT switch from microphone.
57	EPTT	Input port for the PTT switch from the external connector (J6). Low : External PTT switch is ON.
58	HANG	Input port for the microphone hanger detection signal. Low : Microphone on hook.
59	AFVI	Input port for the AF volume control signal (R14). High : [VOL] is maximum clockwise.
60	CDEC	Input port for the CTCSS/DTCS decoding signals.
61	SDEC	Input port for the single tone decoding signal.
62	OPV1V2	Input port for the optional board detection signal.
63	RSSI	Input port for receiving signal strength level detection.
64	LVIN	Input port for the PLL lock voltage.

4-5-2 OUTPUT EXPANDER (MAIN UNIT; IC17)

Pin number	Port name	Description
4	RXC	Outputs transmit/receive control signal. High: While receiving.
5	AFON	Outputs audio output control signal. High: While receiving.
6	NWC	Outputs wide/narrow control signal. High: Wide is selected.
7	RMUT	Outputs receiving mute control signal. Low: While receiving is muting.
13	TMUT	Outputs transmitting mute control signal. Low: While transmitting is muting.
14	MMUT	Outputs the microphone mute control signal. Low: While the microphone is muting.

4-5-3 LCD DRIVER (FRONT UNIT; IC6)

Pin number	Port name	Description
1	LIGT1	Outputs dimmer control signal. High: Dimmter is ON.
2	LIGT2	Outputs backlight control signal. High: Backlight is ON.
3–34	SEG32–SEG1	Output LCD segment signals.
35–38	COM4–COM1	Output LCD common signals.

SECTION 5 ADJUSTMENT PROCEDURES

5-1 PREPARATION

When you adjust the contents on pages 5-5 and 5-6, SOFTWARE ADJUSTMENT, the optional CS-F100 ADJ ADJUSTMENT SOFTWARE (Rev. 1.0 or later), *OPC-1122 JIG CABLE (modified OPC-1122 CLONING CABLE; see illustration below) are required.

SYSTEM REQUIREMENTS

- IBM PC compatible computer with an RS-232C serial port (38400 bps or faster).
- Microsoft Windows 95/98 or Windows ME
- Intel Pentium 100 MHz processor or faster
- At least 16 MB RAM and 10 MB of hard disk space
- 640x480 pixel display (800x600 pixel display recommended)

IBM is a registered trademark of International Business Machines Corporation in the U.S.A. and other countries. Microsoft and Windows are registered trademarks of Microsoft Corporation in the U.S.A. and other countries. Screen shots produced with permission from Microsoft Corporation. All other products or brands are registered trademarks or trademarks of their respective holders.

ADJUSTMENT SOFTWARE INSTALLATION

- ① Boot up Windows.
 - Quit all applications when Windows is running.
- ② Insert the 'CS-F100' into the appropriate CD drive.
- ③ Select 'Run' from the [Start] menu.
- ④ Type the setup program name using the full path name, then push [Enter] key.
(ex. D:\CSF100ADJ\Setup.exe)
- ⑤ Follow the prompts.
- ⑥ Program group 'CS-F100 ADJ' appears in the 'Programs' folder of the [Start] menu.

STARTING SOFTWARE ADJUSTMENT

- ① Connect IC-F110 and PC with *OPC-1122 JIG CABLE.
- ② Turn the transceiver power ON.
- ③ Boot up Windows, and click the program group 'CS-F100 ADJ' in the 'Programs' folder of the [Start] menu, then CS-F100 ADJ's window appears.
- ④ Click 'Connect' on the CS-F100 ADJ's window, then appears IC-F110's up-to-date condition.
- ⑤ Set or modify adjustment data as desired.

*OPC-1122 (JIG CABLE)

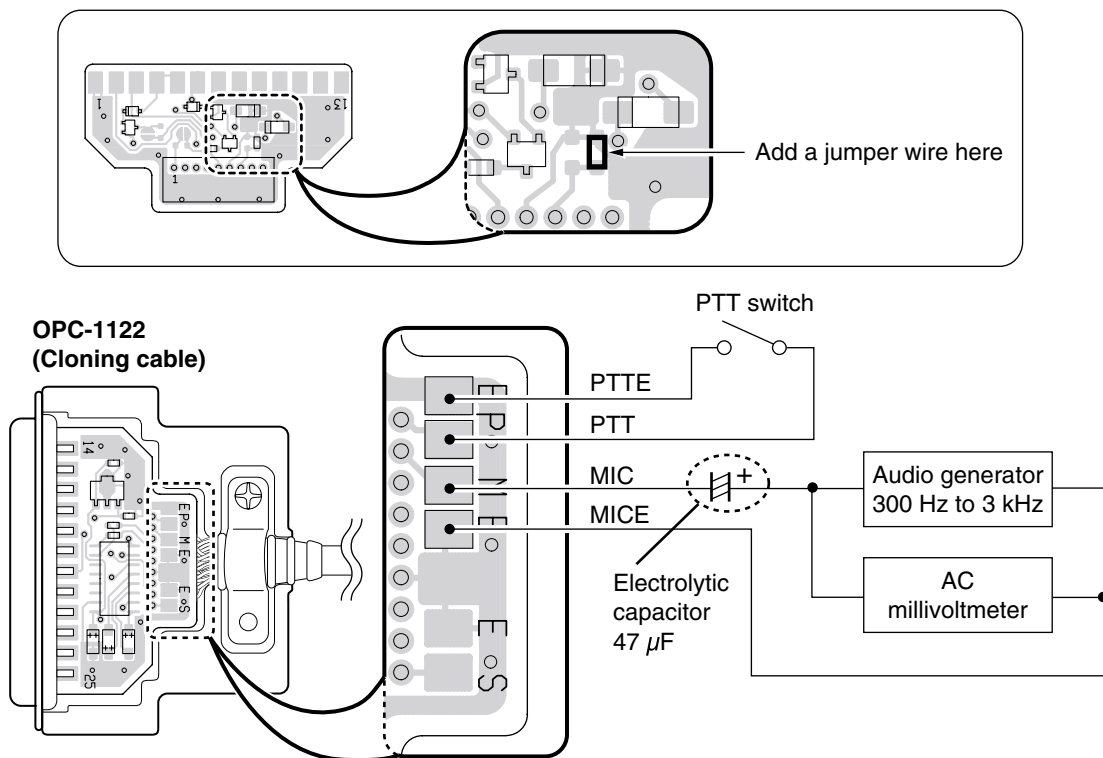

■ REQUIRED TEST EQUIPMENT

EQUIPMENT	GRADE AND RANGE	EQUIPMENT	GRADE AND RANGE
DC power supply	Output voltage : 13.2 V DC Current capacity : 15 A or more	Audio generator	Frequency range : 300–3000 Hz Measuring range : 1–500 mV
RF power meter (terminated type)	Measuring range : 1–100 W Frequency range : 100–300 MHz Impedance : 50 Ω SWR : Less than 1.2 : 1	Standard signal generator (SSG)	Frequency range : 0.1–300 MHz Output level : 0.1 μV–32 mV (–127 to –17 dBm)
Frequency counter	Frequency range : 0.1–300 MHz Frequency accuracy : ±1 ppm or better Sensitivity : 100 mV or better	Oscilloscope	Frequency range : DC–20 MHz Measuring range : 0.01–20 V
FM deviation meter	Frequency range : DC–300 MHz Measuring range : 0 to ±10 kHz	AC millivoltmeter	Measuring range : 10 mV–10 V
DC voltmeter	Input impedance : 50 kΩ/V DC or better	External speaker	Input impedance : 4 Ω Capacity : 7 W or more
		Attenuator	Power attenuation : 40 or 50 dB Capacity : 50 W or more

• CONNECTIONS

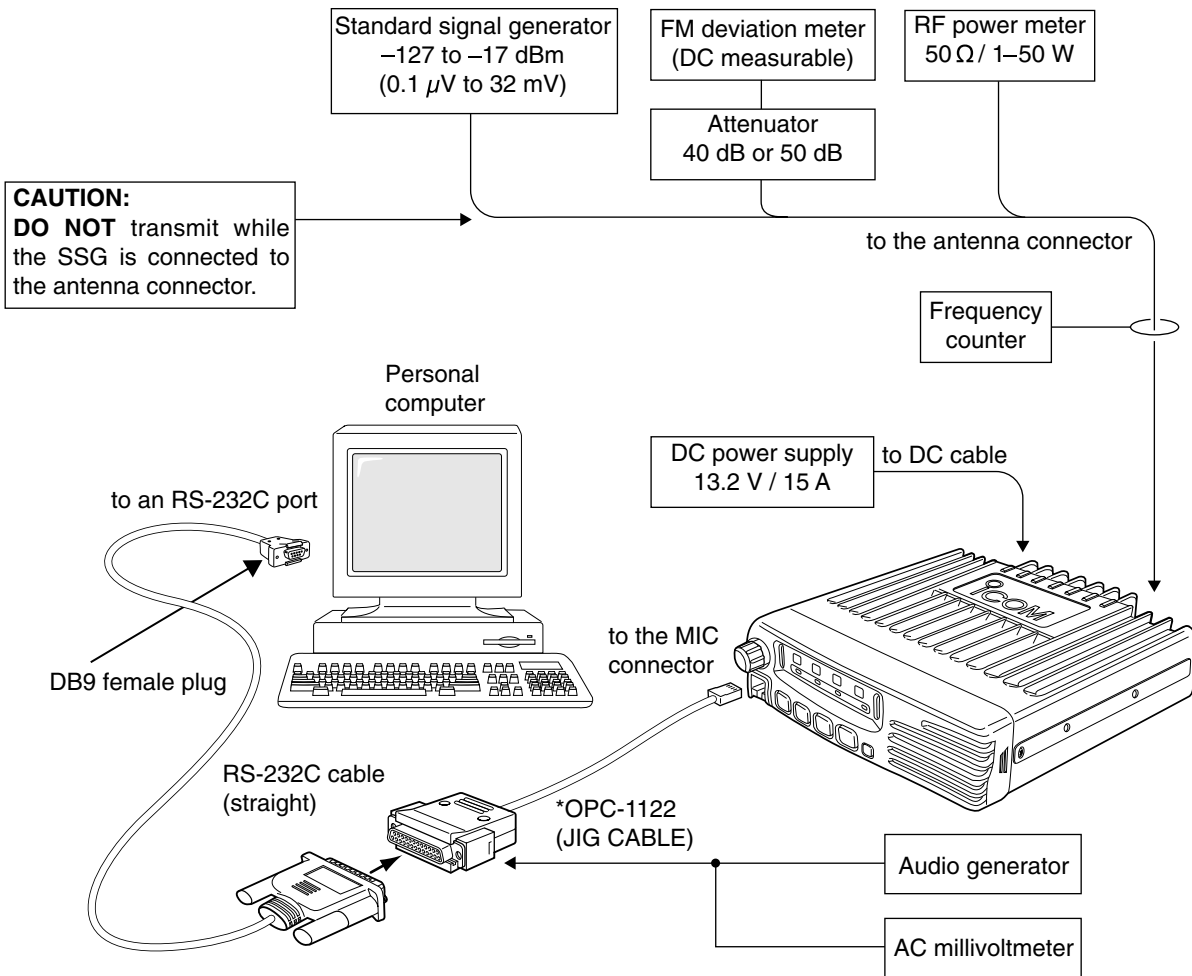

• SCREEN DISPLAY EXAMPLE

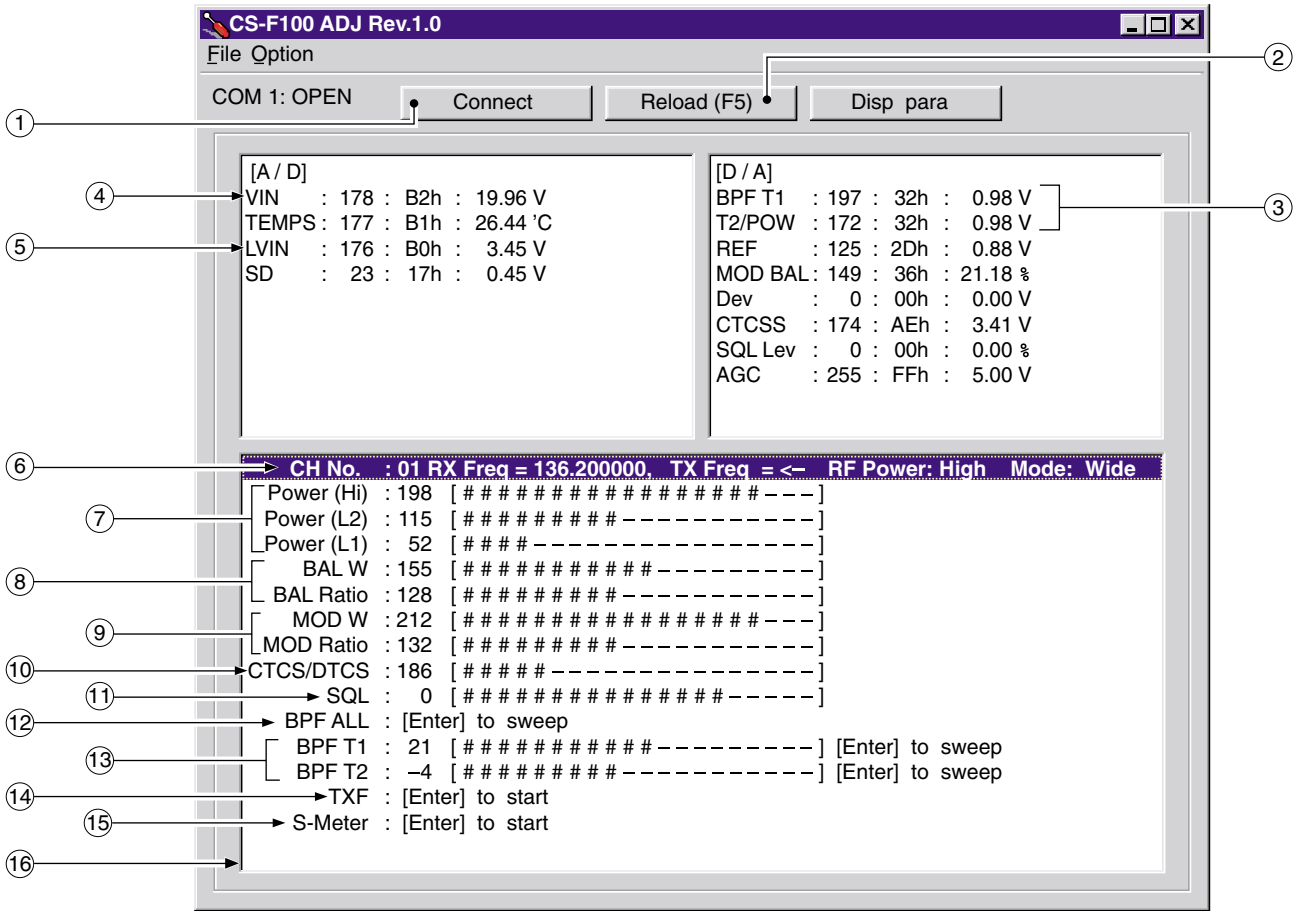

NOTE: The above values for settings are example only.
Each transceiver has its own specific values for each setting.

- | | |
|------------------------------------|--|
| ①: Transceiver's connection state | ⑨: FM deviation |
| ②: Reload adjustment data | ⑩: CTCSS/DTCS deviation |
| ③: Receive sensitivity measurement | ⑪: Squelch level |
| ④: Connected DC voltage | ⑫: Receive sensitivity (automatically) |
| ⑤: PLL lock voltage | ⑬: Receive sensitivity (manually) |
| ⑥: Operating channel select | ⑭: Reference frequency |
| ⑦: RF output power | ⑮: S-meter |
| ⑧: Modulation balance | ⑯: Adjustment items |

5-2 PLL ADJUSTMENT

ADJUSTMENT	ADJUSTMENT CONDITIONS	MEASUREMENT		VALUE	ADJUSTMENT		
		UNIT	LOCATION		UNIT	ADJUST	
PLL LOCK VOLTAGE	1 • Operating freq. : 174.000 MHz • Receiving	MAIN	Connect a digital multi-meter or an oscilloscope to the check point, "LV".	3.2 V	MAIN	C134	
	2 • Output power : Low1 • Transmitting					3.6 V	C133
	3 • Operating freq. : 136.000 MHz • Receiving					0.9–1.5 V	Verify
	4 • Output power : Low1 • Transmitting					0.8–1.4 V	

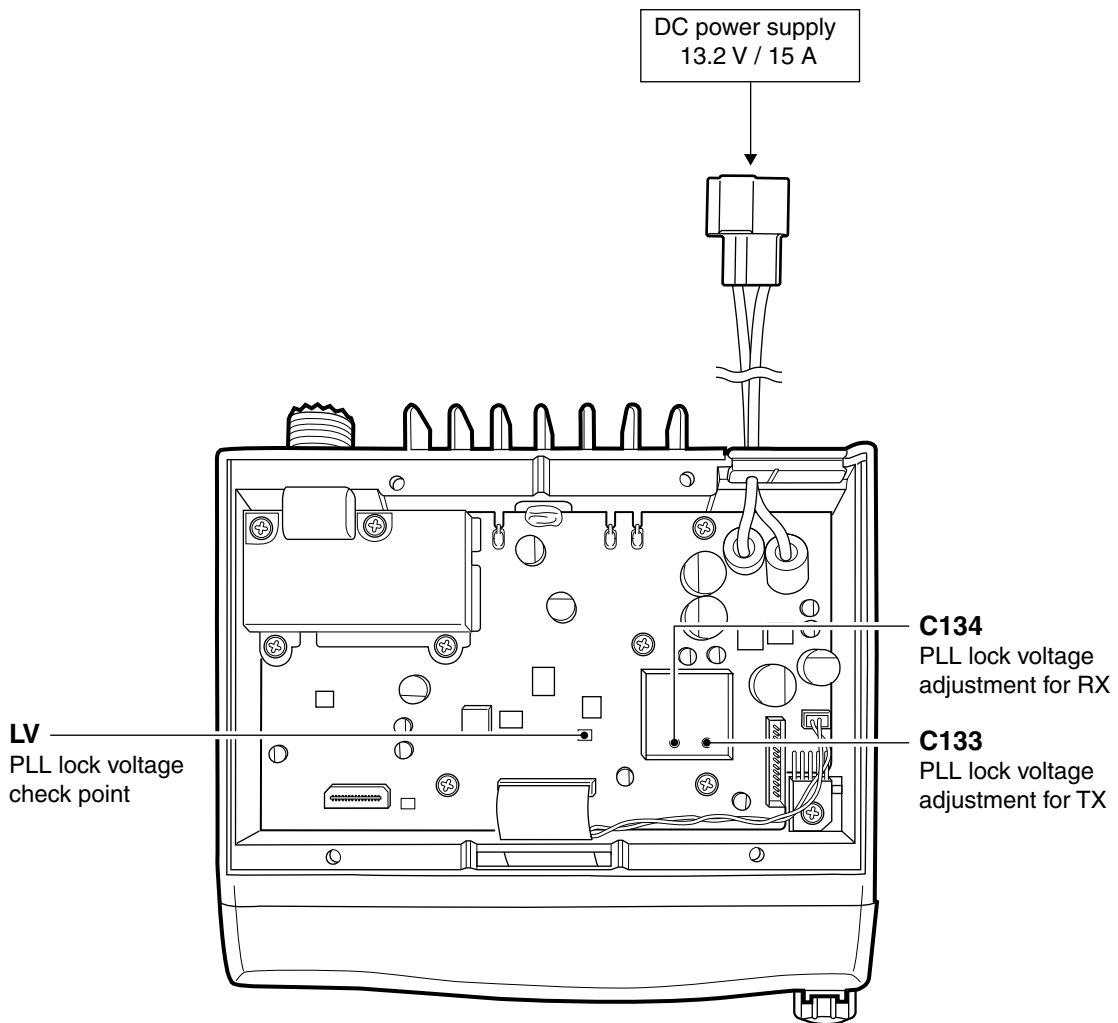

5-3 SOFTWARE ADJUSTMENT

Select an operation using [↑] / [↓] keys, then set specified value using [←] / [→] keys on the connected computer keyboard.

ADJUSTMENT	ADJUSTMENT CONDITION	MEASUREMENT		VALUE
		UNIT	LOCATION	
REFERENCE FREQUENCY [TXF]	1 <ul style="list-style-type: none"> • Operating freq. : 174.000 MHz • Output power : Low1 • Connect the RF power meter or 50 Ω dummy load to the antenna connector. • Transmitting 	Rear panel	Loosely couple a frequency counter to the antenna connector.	174.0000 MHz
OUTPUT POWER [Power (Hi)]	1 <ul style="list-style-type: none"> • Operating freq. : 155.000 MHz • Output power : High • Transmitting 	Rear panel	Connect an RF power meter to the antenna connector.	25.0 W (25 W type) 50.0 W (50 W type)
[Power (L2)]	2 <ul style="list-style-type: none"> • Output power : Low2 • Transmitting 			10.0 W (25 W type) 25.0 W (50 W type)
[Power (L1)]	3 <ul style="list-style-type: none"> • Output power : Low1 • Transmitting 			2.5 W (25 W type) 5.0 W (50 W type)
FM DEVIATION [MOD W]	1 <ul style="list-style-type: none"> • Operating freq. : 155.000 MHz • Output power : Low1 • IF bandwidth : Wide • Connect an audio generator to the [MIC] jack through the JIG cable and set as: 1.0 kHz/40 mVrms • Set an FM deviation meter as: HPF : OFF LPF : 20 kHz De-emphasis: OFF Detector : (P-P)/2 • Transmitting 	Rear panel	Connect an FM deviation meter to the antenna connector through the attenuator.	±4.1 kHz [N/W] ±3.3 kHz [N/M]
[MOD Ratio]	2 <ul style="list-style-type: none"> • IF bandwidth : Narrow • Transmitting 			±2.1 kHz
MODULATION BALLANCE [BAL W]	1 <ul style="list-style-type: none"> • Set to the DTCS set channel, and push [Connect] on the Adjustment software. • Operating freq. : 155.000 MHz • Output power : Low1 • Transmitting 	Rear panel	Connect an FM deviation meter with an oscilloscope to the antenna connector through an attenuator.	Set to square wave form 
[BAL Ratio]	2 <ul style="list-style-type: none"> • IF bandwidth : Narrow • Transmitting 			
CTCSS/DTCS DEVIATION [CTCS/DTCS]	1 <ul style="list-style-type: none"> • Operating freq. : 155.000 MHz • Output power : Low1 • IF bandwidth : Wide • CTCSS : 151.4 Hz • DTCS code : 007 • Set the FM deviation meter as: HPF : OFF LPF : 20 kHz De-emphasis: OFF Detector : (P-P)/2 • No audio applied to the [MIC] connector. • Transmitting 	Rear panel	Connect an FM deviation meter to the antenna connector through the attenuator.	±0.7 kHz [N/W] ±0.56 kHz [N/W]

SOFTWARE ADJUSTMENT – continued

Select an operation using [↑] / [↓] keys, then set specified value using [←] / [→] keys on the connected computer keyboard.

ADJUSTMENT	ADJUSTMENT CONDITION	MEASUREMENT		VALUE
		UNIT	LOCATION	
RX SENSITIVITY [BPF T1], [BPF T2]	1 <ul style="list-style-type: none"> Operating freq. : 136.000 MHz IF bandwidth : Wide Connect a standard signal generator to the antenna connector and set as: <ul style="list-style-type: none"> Frequency : 136.000 MHz Level : 10 μV^* (-87 dBm) Modulation : 1 kHz Deviation : ± 3.5 kHz [N/W] ± 2.8 kHz [N/M] Receiving <p>CONVENIENT: The BPF T1–BPF T2 can be adjusted automatically.</p> <p>①-1: Set the cursor to “BPF ALL” on the adjustment program and then push [ENTER] key.</p> <p>①-2: The connected PC tunes BPF T1, BPF T2 to peak levels.</p> <p>or</p> <p>②-1: Set the cursor to BPF T1 or BPF T2 as desired.</p> <p>②-2: Push [ENTER] key to start tuning.</p> <p>②-3: Repeat ②-1 and ②-2 to perform additional BPF tuning.</p>	MAIN	Connect a SINAD meter with a 4 Ω load to the external [SP] jack.	Minimum distortion level
SQUELCH LEVEL [SQL]	1 <ul style="list-style-type: none"> Operating freq. : 136.000 MHz IF bandwidth : Narrow Connect an SSG to the antenna connector and set as: <ul style="list-style-type: none"> Frequency : 136.000 MHz Level : 0.2 μV^* (-121 dBm) Modulation : 1 kHz Deviation : ± 1.75 kHz Receiving 	Rear panel	Connect a SINAD meter with a 4 Ω load to the external [SP] jack.	Set “SQL level” to close squelch. Then set “SQL level” at the point where the audio signals just appears.
S-METER [S-METER] (S3 LEVEL)	1 <ul style="list-style-type: none"> Operating freq. : 136.000 MHz IF bandwidth : Wide Connect an SSG to the antenna connector and set as: <ul style="list-style-type: none"> Frequency : 136.000 MHz Level : 14 μV^* (-84 dBm) Modulation : 1 kHz Deviation : ± 3.5 kHz [N/W] ± 2.8 kHz [N/M] Receiving 	<ul style="list-style-type: none"> Adjusting S3 and S1’s S-meter level automatically when push the return key on the key board. 		
(S1 LEVEL)	2 <ul style="list-style-type: none"> Set an SSG as: <ul style="list-style-type: none"> Level : 0.45 μV^* (-114 dBm) 			

*The output level of the standard signal generator (SSG) is indicated as the SSG’s open circuit.

SECTION 6 PARTS LIST

[FRONT UNIT]

REF NO.	ORDER NO.	DESCRIPTION	
IC1	1140011260	S.IC	HD6433687A11FP (FX-2622A)
IC2	1110005770	S.IC	S-80942CNMC-G9C-T2
IC3	1140008650	S.IC	HN58X2464TI
IC5	1110005340	S.IC	NJM12902V-TE1
IC6	1130009090	S.IC	LC75834W
Q1	1530002850	S.TRANSISTOR	2SC4116-BL (TE85R)
Q2	1590001050	S.TRANSISTOR	DTC114TUA T106
Q3	1590000430	S.TRANSISTOR	DTC144EUA T106
Q5	1590001050	S.TRANSISTOR	DTC114TUA T106
D1	1790000950	S.ZENER	MA8056-M (TX)
D2	1790000950	S.ZENER	MA8056-M (TX)
D3	1790000950	S.ZENER	MA8056-M (TX)
D4	1790000620	S.DIODE	MA77 (TX)
D5	1790001250	S.DIODE	MA2S111-(TX)
X1	6050009520	S.XTAL	CR-520 (19.6608 MHz+)
L1	6200003640	S.COIL	MLF1608E 100K-T
L2	6200001980	S.COIL	NL 252018T-1R0J
R7	7030009160	S.RESISTOR	ERJ2GEJ 181 X (180 Ω)
R8	7030009160	S.RESISTOR	ERJ2GEJ 181 X (180 Ω)
R9	7030005000	S.RESISTOR	ERJ2GEJ 471 X (470 Ω)
R11	7030009280	S.RESISTOR	ERJ2GE
R12	7030009140	S.RESISTOR	ERJ2GEJ 272 X (2.7 kΩ)
R14	7210003020	VARIABLE	EVU-F2KFK1 B14 (10KB)
R15	7030005120	S.RESISTOR	ERJ2GEJ 102 X (1 kΩ)
R16	7030005120	S.RESISTOR	ERJ2GEJ 102 X (1 kΩ)
R18	7030005090	S.RESISTOR	ERJ2GEJ 104 X (100 kΩ)
R19	7030005090	S.RESISTOR	ERJ2GEJ 104 X (100 kΩ)
R20	7030008300	S.RESISTOR	ERJ2GEJ 184 X (180 kΩ)
R21	7030005720	S.RESISTOR	ERJ2GEJ 563 X (56 kΩ)
R22	7030005220	S.RESISTOR	ERJ2GEJ 223 X (22 kΩ)
R23	7030005240	S.RESISTOR	ERJ2GEJ 473 X (47 kΩ)
R24	7030005240	S.RESISTOR	ERJ2GEJ 473 X (47 kΩ)
R25	7030005220	S.RESISTOR	ERJ2GEJ 223 X (22 kΩ)
R26	7030005240	S.RESISTOR	ERJ2GEJ 473 X (47 kΩ)
R27	7030005240	S.RESISTOR	ERJ2GEJ 473 X (47 kΩ)
R28	7030005040	S.RESISTOR	ERJ2GEJ 472 X (4.7 kΩ)
R29	7030008290	S.RESISTOR	ERJ2GEJ 183 X (18 kΩ)
R30	7030005110	S.RESISTOR	ERJ2GEJ 224 X (220 kΩ)
R31	7030005090	S.RESISTOR	ERJ2GEJ 104 X (100 kΩ)
R32	7030005240	S.RESISTOR	ERJ2GEJ 473 X (47 kΩ)
R33	7030005220	S.RESISTOR	ERJ2GEJ 223 X (22 kΩ)
R34	7030005220	S.RESISTOR	ERJ2GEJ 223 X (22 kΩ)
R35	7030005070	S.RESISTOR	ERJ2GEJ 683 X (68 kΩ)
R36	7030005070	S.RESISTOR	ERJ2GEJ 683 X (68 kΩ)
R37	7030005070	S.RESISTOR	ERJ2GEJ 683 X (68 kΩ)
R38	7030005070	S.RESISTOR	ERJ2GEJ 683 X (68 kΩ)
R39	7030005070	S.RESISTOR	ERJ2GEJ 683 X (68 kΩ)
R40	7030005240	S.RESISTOR	ERJ2GEJ 473 X (47 kΩ)
R41	7030005050	S.RESISTOR	ERJ2GEJ 103 X (10 kΩ)
R42	7030007350	S.RESISTOR	ERJ2GEJ 393 X (39 kΩ)
R43	7030005060	S.RESISTOR	ERJ2GEJ 333 X (33 kΩ)
R44	7030005100	S.RESISTOR	ERJ2GEJ 154 X (150 kΩ)
R45	7030005530	S.RESISTOR	ERJ2GEJ 100 X (10 Ω)
R46	7030005160	S.RESISTOR	ERJ2GEJ 105 X (1 MΩ)
R47	7030008010	S.RESISTOR	ERJ2GEJ 123 X (12 kΩ)
R48	7030008010	S.RESISTOR	ERJ2GEJ 123 X (12 kΩ)
R49	7030008010	S.RESISTOR	ERJ2GEJ 123 X (12 kΩ)
R50	7410001130	S.ARRAY	EXB28V102JX
R51	7030005090	S.RESISTOR	ERJ2GEJ 104 X (100 kΩ)
R52	7030005120	S.RESISTOR	ERJ2GEJ 102 X (1 kΩ)
R54	7410001130	S.ARRAY	EXB28V102JX
R55	7410000770	S.ARRAY	EXB-V4V 102JV (1 kΩ)
R56	7410001130	S.ARRAY	EXB28V102JX
R57	7030005160	S.RESISTOR	ERJ2GEJ 105 X (1 MΩ)
R58	7030005050	S.RESISTOR	ERJ2GEJ 103 X (10 kΩ)
R59	7310002740	S.TRIMMER	RV-150 (RH03A3A14X0FC) 103

[FRONT UNIT]

REF NO.	ORDER NO.	DESCRIPTION	
R60	7030005090	S.RESISTOR	ERJ2GEJ 104 X (100 kΩ)
R65	7030005120	S.RESISTOR	ERJ2GEJ 102 X (1 kΩ)
R67	7030005050	S.RESISTOR	ERJ2GEJ 103 X (10 kΩ)
R68	7030005050	S.RESISTOR	ERJ2GEJ 103 X (10 kΩ)
R73	7030005050	S.RESISTOR	ERJ2GEJ 103 X (10 kΩ)
R74	7030005050	S.RESISTOR	ERJ2GEJ 103 X (10 kΩ)
R75	7030005050	S.RESISTOR	ERJ2GEJ 103 X (10 kΩ)
R76	7030005120	S.RESISTOR	ERJ2GEJ 102 X (1 kΩ)
R77	7030005030	S.RESISTOR	ERJ2GEJ 152 X (1.5 kΩ)
R78	7030005240	S.RESISTOR	ERJ2GEJ 473 X (47 kΩ)
R79	7410000770	S.ARRAY	EXB-V4V 102JV (1 kΩ)
R80	7030005090	S.RESISTOR	ERJ2GEJ 104 X (100 kΩ)
R81	7030005090	S.RESISTOR	ERJ2GEJ 104 X (100 kΩ)
R82	7030005090	S.RESISTOR	ERJ2GEJ 104 X (100 kΩ)
R83	7030005090	S.RESISTOR	ERJ2GEJ 104 X (100 kΩ)
R84	7030005090	S.RESISTOR	ERJ2GEJ 104 X (100 kΩ)
R85	7030005090	S.RESISTOR	ERJ2GEJ 104 X (100 kΩ)
R86	7030005090	S.RESISTOR	ERJ2GEJ 104 X (100 kΩ)
R87	7030005090	S.RESISTOR	ERJ2GEJ 104 X (100 kΩ)
R88	7030005090	S.RESISTOR	ERJ2GEJ 104 X (100 kΩ)
R89	7030005090	S.RESISTOR	ERJ2GEJ 104 X (100 kΩ)
R90	7030006610	S.RESISTOR	ERJ2GEJ 394 X (390 kΩ)
C1	4030018100	S.CERAMIC	ECJ0EB1H681K
C2	4030017420	S.CERAMIC	ECJ0EC1H470J
C3	4030017420	S.CERAMIC	ECJ0EC1H470J
C4	4030017420	S.CERAMIC	ECJ0EC1H470J
C5	4030017420	S.CERAMIC	ECJ0EC1H470J
C6	4030017420	S.CERAMIC	ECJ0EC1H470J
C7	4030017420	S.CERAMIC	ECJ0EC1H470J
C8	4030017460	S.CERAMIC	ECJ0EB1E102K
C9	4030017460	S.CERAMIC	ECJ0EB1E102K
C10	4030017460	S.CERAMIC	ECJ0EB1E102K
C11	4030017420	S.CERAMIC	ECJ0EC1H470J
C12	4030017460	S.CERAMIC	ECJ0EB1E102K
C14	4030017460	S.CERAMIC	ECJ0EB1E102K
C15	4030016780	S.CERAMIC	ECJ0EB1C153K
C16	4030016930	S.CERAMIC	ECJ0EB1A104K
C17	4030017740	S.CERAMIC	ECJ0EB1E821K
C19	4030016930	S.CERAMIC	ECJ0EB1A104K
C20	4030018110	S.CERAMIC	ECJ0EB1H272K
C21	4030018240	S.CERAMIC	ECJ0EB1E562K
C22	4030017710	S.CERAMIC	ECJ0EC1H181J
C23	4030018090	S.CERAMIC	ECJ0EB1C822K
C24	4030017510	S.CERAMIC	ECJ0EC1H680J
C25	4030016790	S.CERAMIC	ECJ0EB1C103K
C26	4030016930	S.CERAMIC	ECJ0EB1A104K
C27	4030017450	S.CERAMIC	ECJ0EB1E271K
C28	4030016930	S.CERAMIC	ECJ0EB1A104K
C29	4550006050	S.TANTALUM	TEMSVA 0J 106M8L
C30	4030017030	S.CERAMIC	ECJ0EB1A273K
C31	4030017400	S.CERAMIC	ECJ0EC1H220J
C32	4030017640	S.CERAMIC	ECJ0EC1H150J
C33	4030017510	S.CERAMIC	ECJ0EC1H680J
C34	4030017730	S.CERAMIC	ECJ0EB1E471K
C35	4030016930	S.CERAMIC	ECJ0EB1A104K
C36	4030016930	S.CERAMIC	ECJ0EB1A104K
C37	4030017420	S.CERAMIC	ECJ0EC1H470J
C38	4030017420	S.CERAMIC	ECJ0EC1H470J
C41	4030017460	S.CERAMIC	ECJ0EB1E102K
C50	4030017420	S.CERAMIC	ECJ0EC1H470J
C54	4030017420	S.CERAMIC	ECJ0EC1H470J
C69	4030017420	S.CERAMIC	ECJ0EC1H470J
C74	4030017420	S.CERAMIC	ECJ0EC1H470J
C75	4030016930	S.CERAMIC	ECJ0EB1A104K
C76	4030016930	S.CERAMIC	ECJ0EB1A104K
C77	4030016950	S.CERAMIC	ECJ0EB1A473K
C78	4030017460	S.CERAMIC	ECJ0EB1E102K
C79	4030016930	S.CERAMIC	ECJ0EB1A104K
C80	4030016930	S.CERAMIC	ECJ0EB1A104K
C81	4030017460	S.CERAMIC	ECJ0EB1E102K
C82	4030017420	S.CERAMIC	ECJ0EC1H470J
C83	4030017420	S.CERAMIC	ECJ0EC1H470J
C84	4030017420	S.CERAMIC	ECJ0EC1H470J
C85	4030017420	S.CERAMIC	ECJ0EC1H470J

Ⓐ: [F110] Ⓑ: [F111] and [F121] Ⓒ: IC-F110 for [EUR]
 Ⓓ: IC-F110 for [GEN] Ⓔ: IC-F110 for 25 kHz Ⓕ: IC-F110 for 20 kHz

S.=Surface mount

[FRONT UNIT]

REF NO.	ORDER NO.	DESCRIPTION	
J1	6450002210	CONNECTOR	3017-8821 <KIN>
J2	6510022470	S.CONNECTOR	40FLT-SM1-TB
DS1	5040002310	S.LED	SML-311YTT86
DS2	5040002310	S.LED	SML-311YTT86
DS3	5040002310	S.LED	SML-311YTT86
DS4	5040002310	S.LED	SML-311YTT86
DS5	5040002310	S.LED	SML-311YTT86
DS6	5040002310	S.LED	SML-311YTT86
DS7	5040002310	S.LED	SML-311YTT86
DS8	5040002310	S.LED	SML-311YTT86
DS9	5040002310	S.LED	SML-311YTT86
DS11	5030002510	LCD	L2-0607TAY
SP1	2510001220	SPEAKER	C052SB500-13
W1	8900010500	CABLE	OPC-1046
EP1	0910055684	PCB	B 5910D
EP2	8930059170	LCD CONTACT	SRCN-2622-SP-N-W

[MAIN UNIT]

REF NO.	ORDER NO.	DESCRIPTION	
Q38	1530003090	S.TRANSISTOR	2SC4213-B (TE85R)
D1	1790001210	S.DIODE	1SS375-TL
D2	1750000510	S.DIODE	UM9401F
D3	1710001060	DIODE	XB15A407
D4	1750000720	S.VARICAP	HVC375BTRF
D5	1750000510	S.DIODE	UM9401F
D6	1790000620	S.DIODE	MA77 (TX)
D7	1790001240	S.DIODE	MA2S728-(TX)
D8	1750000720	S.VARICAP	HVC375BTRF
D9	1750000710	S.VARICAP	HVC350BTRF
D10	1750000710	S.VARICAP	HVC350BTRF
D11	1790001210	S.DIODE	1SS375-TL
D12	1790001210	S.DIODE	1SS375-TL
D14	1790000620	S.DIODE	MA77 (TX)
D15	1790000620	S.DIODE	MA77 (TX)
D16	1750000770	S.VARICAP	HVC376BTRF
D18	1720000470	S.VARICAP	1SV239 (TPH3)
D20	1790001250	S.DIODE	MA2S111-(TX)
D21	1750000830	S.VARICAP	HVC362TRF
D22	1790000700	DIODE	DSA3A1
D23	1750000370	S.DIODE	DA221 TL
D26	1790001250	S.DIODE	MA2S111-(TX)
D27	1790001250	S.DIODE	MA2S111-(TX)
D28	1790001240	S.DIODE	MA2S728-(TX)
D29	1790001250	S.DIODE	MA2S111-(TX)
D31	1750000770	S.VARICAP	HVC376BTRF
D33	1750000770	S.VARICAP	HVC376BTRF
D34	1750000770	S.VARICAP	HVC376BTRF
D37	1790001250	S.DIODE	MA2S111-(TX)
D40	1750000520	S.DIODE	DAN222TL
D42	1160000140	S.DIODE	DAP222 TL
D43	1160000140	S.DIODE	DAP222 TL
D44	1790001250	S.DIODE	MA2S111-(TX)
D45	1790001250	S.DIODE	MA2S111-(TX)
D48	1750000580	S.DIODE	1SV307 (TPH3)
D49	1750000370	S.DIODE	DA221 TL
D50	1790001250	S.DIODE	MA2S111-(TX)
D51	1790001210	S.DIODE	1SS375-TL
F11	2030000150	S.MONOLITH	FL-335 (46.350 MHz)
F12	2020001840	CERAMIC	ALFYM450F=K
F13	2040001440	S.LC	NFE31PT152Z1E9L (NFM60R20T152)
F14	2040001440	S.LC	NFE31PT152Z1E9L (NFM60R20T152)
F15	2040001440	S.LC	NFE31PT152Z1E9L (NFM60R20T152)
X1	6070000190	S.DISCRIMINATOR	CDDBC450KCAY24-R0 (CDBC450CX24)
X2	6050011510	S.XTAL	CR-740 (15.300 MHz)
L1	6200010050	S.COIL	AS080547-47N
L2	6200010050	S.COIL	AS080547-47N
L3	6200010050	S.COIL	AS080547-47N
L4	6200010430	S.COIL	0.50-2.0-6TL
L5	6200010420	S.COIL	FWH1210HC 1R0JGT
L6	6200010400	S.COIL	ELJRE 39NJ 39N
L7	6200008090	S.COIL	LQW2BHN68NJ01L (LQN21A 68NJ04)
L8	6200008090	S.COIL	LQW2BHN68NJ01L (LQN21A 68NJ04)
L9	6200007750	S.COIL	LQW2BHN56NJ01L (LQN21A 56NJ04)
L10	6200004660	S.COIL	MLF1608A 1R8K-T
L11	6200007750	S.COIL	LQW2BHN56NJ01L (LQN21A 56NJ04)
L12	6200009180	S.COIL	ELJRE R10J-F3
L13	6200001620	S.COIL	ELJFC 1R0K-F
L16	6200010050	S.COIL	AS080547-47N
L18	6200009170	S.COIL	ELJRE 47NJ-F2
L19	6200009150	S.COIL	ELJRE 82NJ-F3
L21	6200009150	S.COIL	ELJRE 82NJ-F3
L22	6200009160	S.COIL	ELJRE 68NJ-F3
L25	6200009460	S.COIL	0.25-1.9-7TL 67N
L26	6200008390	S.COIL	0.25-1.9-9TL
L27	6200002000	S.COIL	NL 252018T-3R3J
L28	6200002000	S.COIL	NL 252018T-3R3J
L29	6200004660	S.COIL	MLF1608A 1R8K-T
L31	6200007750	S.COIL	LQW2BHN56NJ01L (LQN21A 56NJ04)
L32	6200010390	S.COIL	ELJRE 33NJ-F3
L33	6200004480	S.COIL	MLF1608D R82K-T
L35	6200003540	S.COIL	MLF1608D R22K-T

[MAIN UNIT]

REF NO.	ORDER NO.	DESCRIPTION	
IC1	1110003490	S.IC	TA31136FN (D,EL)
IC2	1110002750	S.IC	TA75S01F (TE85R)
IC3	1150002100	IC	S-AV32 (I)
	1150002110	IC	S-AV33 (I)
IC4	1140005990	S.IC	MB15A02PFV1-G-BND-ER
IC5	1110005330	S.IC	NJM12904V-TE1
IC6	1190000350	S.IC	M62363FP-650C
IC8	1110003090	IC	LA425A
IC9	1180001250	S.IC	TA7808F (TE16L)
IC10	1180000970	S.IC	AN78L05M-(E1)
IC14	1130008090	S.IC	BU4066BCFV-E1
IC15	1110002750	S.IC	TA75S01F (TE85R)
IC16	1110005340	S.IC	NJM12902V-TE1
IC17	1130007570	S.IC	BU4094BCFV-E2
Q1	1560000840	S.FET	2SK1829 (TE85R)
Q2	1580000730	S.FET	3SK293 (TE85L)
Q3	1580000760	S.FET	3SK299-T1 U73
Q4	1530002600	S.TRANSISTOR	2SC4215-O (TE85R)
Q5	1590000430	S.TRANSISTOR	DTC144EUA T106
Q8	1530000370	S.TRANSISTOR	2SC3356-T1B
Q10	1530003310	S.TRANSISTOR	2SC5107-O (TE85R)
Q11	1530003310	S.TRANSISTOR	2SC5107-O (TE85R)
Q12	1530003310	S.TRANSISTOR	2SC5107-O (TE85R)
Q13	1530002920	S.TRANSISTOR	2SC4226-T1 R25
Q14	1530002920	S.TRANSISTOR	2SC4226-T1 R25
Q15	1590001400	S.TRANSISTOR	XP1214 (TX)
Q16	1590000430	S.TRANSISTOR	DTC144EUA T106
Q17	1530002850	S.TRANSISTOR	2SC4116-BL (TE85R)
Q18	1560000540	S.FET	2SK880-Y (TE85R)
Q19	1530002600	S.TRANSISTOR	2SC4215-O (TE85R)
Q20	1530002850	S.TRANSISTOR	2SC4116-BL (TE85R)
Q23	1550000020	S.FET	2SJ377 (TE16R)
Q24	1590000430	S.TRANSISTOR	DTC144EUA T106
Q25	1540000550	S.TRANSISTOR	2SD1664 T100Q
Q26	1510000920	S.TRANSISTOR	2SA1577 T106 Q
Q27	1510000920	S.TRANSISTOR	2SA1577 T106 Q
Q28	1590001190	S.TRANSISTOR	XP6501-(TX) .AB
Q29	1590001050	S.TRANSISTOR	DTC114TUA T106
Q30	1590000430	S.TRANSISTOR	DTC144EUA T106
Q31	1590001450	S.FET	2SJ144-GR (TE85R)
Q33	1590000430	S.TRANSISTOR	DTC144EUA T106
Q34	1530002850	S.TRANSISTOR	2SC4116-BL (TE85R)
Q35	1590000990	S.TRANSISTOR	DTC363EK T146
Q36	1590000430	S.TRANSISTOR	DTC144EUA T106
Q37	1590000430	S.TRANSISTOR	DTC144EUA T106

Ⓐ: [F110] Ⓑ: [F111] and [F121] Ⓒ: IC-F110 for [EUR]
 Ⓓ: IC-F110 for [GEN] Ⓔ: IC-F110 for 25 kHz Ⓕ: IC-F110 for 20 kHz

S.=Surface mount

[MAIN UNIT]

REF NO.	ORDER NO.		DESCRIPTION	
L37	6200003640	S.COIL	MLF1608E 100K-T	
L38	6200009460	S.COIL	0.25-1.9-7TL 67N	
L39	6200008150	S.COIL	0.35-1.6-7TL 44N	
L41	6200009160	S.COIL	ELJRE 68NJ-F3	
L42	6200003550	S.COIL	MLF1608A 4R7K-T	
L43	6200005740	S.COIL	ELJRE 47NG-F	
R1	7030000620	S.RESISTOR	MCR10EZHZ 100 kΩ	
R2	7030000220	S.RESISTOR	MCR10EZHZ 47 Ω (470)	
R3	7030000220	S.RESISTOR	MCR10EZHZ 47 Ω (470)	
R4	7030003370	S.RESISTOR	ERJ3GEYJ 271 V (270 Ω)	
R5	7030003560	S.RESISTOR	ERJ3GEYJ 103 V (10 kΩ)	(A)
	7030003610	S.RESISTOR	ERJ3GEYJ 273 V (27 kΩ)	(B)
R6	7030003610	S.RESISTOR	ERJ3GEYJ 273 V (27 kΩ)	(B)
	7030003620	S.RESISTOR	ERJ3GEYJ 333 V (33 kΩ)	(A)
R7	7030003370	S.RESISTOR	ERJ3GEYJ 271 V (270 Ω)	
R8	7030006070	S.RESISTOR	ERJ12YJ101U (100 Ω)	
R9	7030003560	S.RESISTOR	ERJ3GEYJ 103 V (10 kΩ)	(B) only
R10	7030003730	S.RESISTOR	ERJ3GEYJ 274 V (270 kΩ)	(B) only
R11	7030003680	S.RESISTOR	ERJ3GEYJ 104 V (100 kΩ)	
R12	7030005530	S.RESISTOR	ERJ2GEJ 100 X (10 Ω)	
R13	7030003680	S.RESISTOR	ERJ3GEYJ 104 V (100 kΩ)	
R14	7030003560	S.RESISTOR	ERJ3GEYJ 103 V (10 kΩ)	
R15	7030003730	S.RESISTOR	ERJ3GEYJ 274 V (270 kΩ)	
R16	7030003370	S.RESISTOR	ERJ3GEYJ 271 V (270 Ω)	
R17	7030003320	S.RESISTOR	ERJ3GEYJ 101 V (100 Ω)	
R18	7030004050	S.RESISTOR	ERJ3GEYJ 1R0 V (1 Ω)	
R19	7030003680	S.RESISTOR	ERJ3GEYJ 104 V (100 kΩ)	
R20	7030003370	S.RESISTOR	ERJ3GEYJ 271 V (270 Ω)	(C)
	7030003400	S.RESISTOR	ERJ3GEYJ 471 V (470 Ω)	(D), (B)
R21	7030003720	S.RESISTOR	ERJ3GEYJ 224 V (220 kΩ)	
R22	7030003560	S.RESISTOR	ERJ3GEYJ 103 V (10 kΩ)	
R23	7030003700	S.RESISTOR	ERJ3GEYJ 154 V (150 kΩ)	
R26	7030003400	S.RESISTOR	ERJ3GEYJ 471 V (470 Ω)	
R27	7030003400	S.RESISTOR	ERJ3GEYJ 471 V (470 Ω)	
R28	7030003210	S.RESISTOR	ERJ3GEYJ 120 V (12 Ω)	
R29	7030003320	S.RESISTOR	ERJ3GEYJ 101 V (100 Ω)	
R31	7030003320	S.RESISTOR	ERJ3GEYJ 101 V (100 Ω)	
R32	7030003340	S.RESISTOR	ERJ3GEYJ 151 V (150 Ω)	
R33	7030003340	S.RESISTOR	ERJ3GEYJ 151 V (150 Ω)	
R34	7030003680	S.RESISTOR	ERJ3GEYJ 104 V (100 kΩ)	
R35	7030003320	S.RESISTOR	ERJ3GEYJ 101 V (100 Ω)	
R36	7030003510	S.RESISTOR	ERJ3GEYJ 392 V (3.9 kΩ)	
R37	7030003490	S.RESISTOR	ERJ3GEYJ 272 V (2.7 kΩ)	(E), (B)
	7030003520	S.RESISTOR	ERJ3GEYJ 472 V (4.7 kΩ)	(F)
R38	7030003680	S.RESISTOR	ERJ3GEYJ 104 V (100 kΩ)	
R39	7030003280	S.RESISTOR	ERJ3GEYJ 470 V (47 Ω)	
R40	7030003460	S.RESISTOR	ERJ3GEYJ 152 V (1.5 kΩ)	
R42	7030003680	S.RESISTOR	ERJ3GEYJ 104 V (100 kΩ)	
R43	7030003400	S.RESISTOR	ERJ3GEYJ 471 V (470 Ω)	
R44	7030003720	S.RESISTOR	ERJ3GEYJ 224 V (220 kΩ)	
R45	7030003700	S.RESISTOR	ERJ3GEYJ 154 V (150 kΩ)	
R46	7030003480	S.RESISTOR	ERJ3GEYJ 222 V (2.2 kΩ)	
R48	7030003710	S.RESISTOR	ERJ3GEYJ 184 V (180 kΩ)	(B) only
R49	7520000230	S.POSISTOR	PRF18BD471QB1RB	(B) only
R50	7030003560	S.RESISTOR	ERJ3GEYJ 103 V (10 kΩ)	
R51	7030003770	S.RESISTOR	ERJ3GEYJ 564 V (560 kΩ)	(A)
	7030003680	S.RESISTOR	ERJ3GEYJ 104 V (100 kΩ)	(B)
R52	7030003580	S.RESISTOR	ERJ3GEYJ 153 V (15 kΩ)	
R53	7030004050	S.RESISTOR	ERJ3GEYJ 1R0 V (1 Ω)	(A)
	7030003360	S.RESISTOR	ERJ3GEYJ 221 V (220 Ω)	(B)
R54	7030003550	S.RESISTOR	ERJ3GEYJ 822 V (8.2 kΩ)	(B)
	7030003560	S.RESISTOR	ERJ3GEYJ 103 V (10 kΩ)	(A)
R55	7030003520	S.RESISTOR	ERJ3GEYJ 472 V (4.7 kΩ)	
R56	7030003700	S.RESISTOR	ERJ3GEYJ 154 V (150 kΩ)	
R57	7030003560	S.RESISTOR	ERJ3GEYJ 103 V (10 kΩ)	
R58	7030003320	S.RESISTOR	ERJ3GEYJ 101 V (100 Ω)	
R59	7030003560	S.RESISTOR	ERJ3GEYJ 103 V (10 kΩ)	(B)
	7030003590	S.RESISTOR	ERJ3GEYJ 183 V (18 kΩ)	(A)
R60	7030003320	S.RESISTOR	ERJ3GEYJ 101 V (100 Ω)	
R61	7030003280	S.RESISTOR	ERJ3GEYJ 470 V (47 Ω)	
R62	7030003290	S.RESISTOR	ERJ3GEYJ 560 V (56 Ω)	
R63	7030003580	S.RESISTOR	ERJ3GEYJ 153 V (15 kΩ)	
R67	7030003320	S.RESISTOR	ERJ3GEYJ 101 V (100 Ω)	(A)
	7030003300	S.RESISTOR	ERJ3GEYJ 680 V (68 Ω)	(B)
R68	7030003560	S.RESISTOR	ERJ3GEYJ 103 V (10 kΩ)	
R69	7030003520	S.RESISTOR	ERJ3GEYJ 472 V (4.7 kΩ)	

[MAIN UNIT]

REF NO.	ORDER NO.		DESCRIPTION	
R70	7030003320	S.RESISTOR	ERJ3GEYJ 101 V (100 Ω)	
R71	7030003320	S.RESISTOR	ERJ3GEYJ 101 V (100 Ω)	
R73	7030003320	S.RESISTOR	ERJ3GEYJ 101 V (100 Ω)	
R74	7030003690	S.RESISTOR	ERJ3GEYJ 124 V (120 kΩ)	
R75	7030003690	S.RESISTOR	ERJ3GEYJ 124 V (120 kΩ)	
R76	7030003400	S.RESISTOR	ERJ3GEYJ 471 V (470 Ω)	
R77	7030003560	S.RESISTOR	ERJ3GEYJ 103 V (10 kΩ)	
R78	7030003440	S.RESISTOR	ERJ3GEYJ 102 V (1 kΩ)	
R79	7030005351	S.RESISTOR	ERA3YED 182V	
R80	7030003440	S.RESISTOR	ERJ3GEYJ 102 V (1 kΩ)	
R83	7030005351	S.RESISTOR	ERA3YED 182V	
R84	7030006571	S.RESISTOR	ERA3YED 392V	
R85	7030006571	S.RESISTOR	ERA3YED 392V	
R86	7030003690	S.RESISTOR	ERJ3GEYJ 124 V (120 kΩ)	
R89	7030003560	S.RESISTOR	ERJ3GEYJ 103 V (10 kΩ)	
R90	7030003640	S.RESISTOR	ERJ3GEYJ 473 V (47 kΩ)	
R91	7030003620	S.RESISTOR	ERJ3GEYJ 333 V (33 kΩ)	
R92	7030003680	S.RESISTOR	ERJ3GEYJ 104 V (100 kΩ)	
R93	7030003440	S.RESISTOR	ERJ3GEYJ 102 V (1 kΩ)	
R95	7030003380	S.RESISTOR	ERJ3GEYJ 331 V (330 Ω)	(C)
	7030003360	S.RESISTOR	ERJ3GEYJ 221 V (220 Ω)	(D), (B)
R96	7030003480	S.RESISTOR	ERJ3GEYJ 222 V (2.2 kΩ)	
R97	7030004050	S.RESISTOR	ERJ3GEYJ 1R0 V (1 Ω)	
R98	7030003480	S.RESISTOR	ERJ3GEYJ 222 V (2.2 kΩ)	
R99	7030003440	S.RESISTOR	ERJ3GEYJ 102 V (1 kΩ)	
R100	7030003560	S.RESISTOR	ERJ3GEYJ 103 V (10 kΩ)	
R101	7030003440	S.RESISTOR	ERJ3GEYJ 102 V (1 kΩ)	
R103	7030003700	S.RESISTOR	ERJ3GEYJ 154 V (150 kΩ)	
R104	7030003450	S.RESISTOR	ERJ3GEYJ 122 V (1.2 kΩ)	
R105	7030003640	S.RESISTOR	ERJ3GEYJ 473 V (47 kΩ)	
R106	7030003670	S.RESISTOR	ERJ3GEYJ 823 V (82 kΩ)	
R110	7030003280	S.RESISTOR	ERJ3GEYJ 470 V (47 Ω)	
R111	7030003500	S.RESISTOR	ERJ3GEYJ 332 V (3.3 kΩ)	
R112	7030003610	S.RESISTOR	ERJ3GEYJ 273 V (27 kΩ)	
R113	7030003480	S.RESISTOR	ERJ3GEYJ 222 V (2.2 kΩ)	
R114	7030003570	S.RESISTOR	ERJ3GEYJ 123 V (12 kΩ)	
R115	7030003510	S.RESISTOR	ERJ3GEYJ 392 V (3.9 kΩ)	
R116	7030003570	S.RESISTOR	ERJ3GEYJ 123 V (12 kΩ)	
R117	7030003710	S.RESISTOR	ERJ3GEYJ 184 V (180 kΩ)	
R118	7030003570	S.RESISTOR	ERJ3GEYJ 123 V (12 kΩ)	
R119	7030003530	S.RESISTOR	ERJ3GEYJ 562 V (5.6 kΩ)	
R120	7030003560	S.RESISTOR	ERJ3GEYJ 103 V (10 kΩ)	
R121	7030003640	S.RESISTOR	ERJ3GEYJ 473 V (47 kΩ)	
R122	7030003530	S.RESISTOR	ERJ3GEYJ 562 V (5.6 kΩ)	
R123	7030003680	S.RESISTOR	ERJ3GEYJ 104 V (100 kΩ)	
R124	7030003520	S.RESISTOR	ERJ3GEYJ 472 V (4.7 kΩ)	
R125	7030003680	S.RESISTOR	ERJ3GEYJ 104 V (100 kΩ)	
R126	7030003400	S.RESISTOR	ERJ3GEYJ 471 V (470 Ω)	
R127	7030003630	S.RESISTOR	ERJ3GEYJ 393 V (39 kΩ)	
R128	7030003560	S.RESISTOR	ERJ3GEYJ 103 V (10 kΩ)	
R129	7030003320	S.RESISTOR	ERJ3GEYJ 101 V (100 Ω)	
R130	7030003600	S.RESISTOR	ERJ3GEYJ 223 V (22 kΩ)	
R133	7030003710	S.RESISTOR	ERJ3GEYJ 184 V (180 kΩ)	
R134	7030003610	S.RESISTOR	ERJ3GEYJ 273 V (27 kΩ)	
R135	7030003730	S.RESISTOR	ERJ3GEYJ 274 V (270 kΩ)	
R136	7030003560	S.RESISTOR	ERJ3GEYJ 103 V (10 kΩ)	
R137	7030003660	S.RESISTOR	ERJ3GEYJ 683 V (68 kΩ)	
R138	7030003680	S.RESISTOR	ERJ3GEYJ 104 V (100 kΩ)	
R139	7030003680	S.RESISTOR	ERJ3GEYJ 104 V (100 kΩ)	
R141	7030005120	S.RESISTOR	ERJ2GEJ 102 X (1 kΩ)	
R142	7410001130	S.ARRAY	EXB28V102JX	
R143	7030005120	S.RESISTOR	ERJ2GEJ 102 X (1 kΩ)	
R144	7030005120	S.RESISTOR	ERJ2GEJ 102 X (1 kΩ)	
R145	7030005120	S.RESISTOR	ERJ2GEJ 102 X (1 kΩ)	
R146	7030005120	S.RESISTOR	ERJ2GEJ 102 X (1 kΩ)	
R147	7410001130	S.ARRAY	EXB28V102JX	
R148	7410001130	S.ARRAY	EXB28V102JX	
R149	7410001130	S.ARRAY	EXB28V102JX	
R150	7410001130	S.ARRAY	EXB28V102JX	
R156	7030003520	S.RESISTOR	ERJ3GEYJ 472 V (4.7 kΩ)	
R159	7030003560	S.RESISTOR	ERJ3GEYJ 103 V (10 kΩ)	
R183	7030003720	S.RESISTOR	ERJ3GEYJ 224 V (220 kΩ)	
R184	7030003620	S.RESISTOR	ERJ3GEYJ 333 V (33 kΩ)	
R185	7030003690	S.RESISTOR	ERJ3GEYJ 124 V (120 kΩ)	
R186	7030003680	S.RESISTOR	ERJ3GEYJ 104 V (100 kΩ)	
R187	7030003560	S.RESISTOR	ERJ3GEYJ 103 V (10 kΩ)	
R188	7030003400	S.RESISTOR	ERJ3GEYJ 471 V (470 Ω)	
R191	7030003720	S.RESISTOR	ERJ3GEYJ 224 V (220 kΩ)	
R192	7030003720	S.RESISTOR	ERJ3GEYJ 224 V (220 kΩ)	
R193	7030003760	S.RESISTOR	ERJ3GEYJ 474 V (470 kΩ)	
R194	7030003480	S.RESISTOR	ERJ3GEYJ 222 V (2.2 kΩ)	

(A): [F110] (B): [F111] and [F121] (C): IC-F110 for [EUR]
 (D): IC-F110 for [GEN] (E): IC-F110 for 25 kHz (F): IC-F110 for 20 kHz

S.=Surface mount

[MAIN UNIT]

REF NO.	ORDER NO.	DESCRIPTION	
R195	7030003440	S.RESISTOR	ERJ3GEYJ 102 V (1 kΩ)
R196	7030003600	S.RESISTOR	ERJ3GEYJ 223 V (22 kΩ)
R197	7030003560	S.RESISTOR	ERJ3GEYJ 103 V (10 kΩ)
R198	7030003560	S.RESISTOR	ERJ3GEYJ 103 V (10 kΩ)
R199	7030003560	S.RESISTOR	ERJ3GEYJ 103 V (10 kΩ)
R200	7030003560	S.RESISTOR	ERJ3GEYJ 103 V (10 kΩ)
R201	7030003400	S.RESISTOR	ERJ3GEYJ 471 V (470 Ω)
R202	7030000440	S.RESISTOR	MCR10EZHZ 3.3 kΩ (A)
	7030000480	S.RESISTOR	MCR10EZHZ 6.8 kΩ (682) (B)
R203	7030000440	S.RESISTOR	MCR10EZHZ 3.3 kΩ (A)
	7030000480	S.RESISTOR	MCR10EZHZ 6.8 kΩ (682) (B)
R204	7030003520	S.RESISTOR	ERJ3GEYJ 472 V (4.7 kΩ)
R205	7030003560	S.RESISTOR	ERJ3GEYJ 103 V (10 kΩ)
R209	7510001470	S.THERMISTOR	NTCG20 4AG 473JT
R210	7030005871	S.RESISTOR	ERA3YKD 104V (100 kΩ)
R211	7030003290	S.RESISTOR	ERJ3GEYJ 560 V (56 Ω)
R212	7030003380	S.RESISTOR	ERJ3GEYJ 331 V (330 Ω)
R213	7030003560	S.RESISTOR	ERJ3GEYJ 103 V (10 kΩ)
R214	7030003460	S.RESISTOR	ERJ3GEYJ 152 V (1.5 kΩ)
R215	7030003400	S.RESISTOR	ERJ3GEYJ 471 V (470 Ω)
R216	7030003460	S.RESISTOR	ERJ3GEYJ 152 V (1.5 kΩ)
R217	7030003600	S.RESISTOR	ERJ3GEYJ 223 V (22 kΩ)
R218	7030003600	S.RESISTOR	ERJ3GEYJ 223 V (22 kΩ)
R219	7030003680	S.RESISTOR	ERJ3GEYJ 104 V (100 kΩ)
R220	7030003640	S.RESISTOR	ERJ3GEYJ 473 V (47 kΩ)
R221	7030003640	S.RESISTOR	ERJ3GEYJ 473 V (47 kΩ)
R222	7030003560	S.RESISTOR	ERJ3GEYJ 103 V (10 kΩ)
R223	7030003440	S.RESISTOR	ERJ3GEYJ 102 V (1 kΩ)
R224	7030003280	S.RESISTOR	ERJ3GEYJ 470 V (47 Ω)
R225	7030003560	S.RESISTOR	ERJ3GEYJ 103 V (10 kΩ)
R226	7030003680	S.RESISTOR	ERJ3GEYJ 104 V (100 kΩ)
R227	7030003800	S.RESISTOR	ERJ3GEYJ 105 V (1 MΩ)
R228	7030003680	S.RESISTOR	ERJ3GEYJ 104 V (100 kΩ)
R229	7030003800	S.RESISTOR	ERJ3GEYJ 105 V (1 MΩ)
R230	7030003660	S.RESISTOR	ERJ3GEYJ 683 V (68 kΩ)
R231	7030004050	S.RESISTOR	ERJ3GEYJ 1R0 V (1 Ω)
R232	7030003630	S.RESISTOR	ERJ3GEYJ 393 V (39 kΩ)
R234	7030003550	S.RESISTOR	ERJ3GEYJ 822 V (8.2 kΩ)
R235	7030003440	S.RESISTOR	ERJ3GEYJ 102 V (1 kΩ)
R236	7030003450	S.RESISTOR	ERJ3GEYJ 122 V (1.2 kΩ)
R237	7030003780	S.RESISTOR	ERJ3GEYJ 684 V (680 kΩ)
R238	7030003680	S.RESISTOR	ERJ3GEYJ 104 V (100 kΩ)
R240	7030003680	S.RESISTOR	ERJ3GEYJ 104 V (100 kΩ)
R241	7030003680	S.RESISTOR	ERJ3GEYJ 104 V (100 kΩ)
R242	7030003630	S.RESISTOR	ERJ3GEYJ 393 V (39 kΩ)
R243	7030003670	S.RESISTOR	ERJ3GEYJ 823 V (82 kΩ)
R244	7030003750	S.RESISTOR	ERJ3GEYJ 394 V (390 kΩ)
R245	7030003710	S.RESISTOR	ERJ3GEYJ 184 V (180 kΩ)
R247	7030003600	S.RESISTOR	ERJ3GEYJ 223 V (22 kΩ)
R248	7030003600	S.RESISTOR	ERJ3GEYJ 223 V (22 kΩ)
R249	7030003600	S.RESISTOR	ERJ3GEYJ 223 V (22 kΩ)
R250	7030003680	S.RESISTOR	ERJ3GEYJ 104 V (100 kΩ)
R251	7030003760	S.RESISTOR	ERJ3GEYJ 474 V (470 kΩ)
R252	7030003400	S.RESISTOR	ERJ3GEYJ 471 V (470 Ω)
R261	7030005160	S.RESISTOR	ERJ2GEJ 105 X (1 MΩ)
R262	7030005160	S.RESISTOR	ERJ2GEJ 105 X (1 MΩ)
R263	7030005160	S.RESISTOR	ERJ2GEJ 105 X (1 MΩ)
R264	7030005070	S.RESISTOR	ERJ2GEJ 683 X (68 kΩ)
R265	7030008290	S.RESISTOR	ERJ2GEJ 183 X (18 kΩ)
R266	7030005240	S.RESISTOR	ERJ2GEJ 473 X (47 kΩ)
R267	7030005600	S.RESISTOR	ERJ2GEJ 273 X (27 kΩ)
R268	7030005050	S.RESISTOR	ERJ2GEJ 103 X (10 kΩ)
R269	7030003680	S.RESISTOR	ERJ3GEYJ 104 V (100 kΩ)
R270	7030003680	S.RESISTOR	ERJ3GEYJ 104 V (100 kΩ)
R271	7030003320	S.RESISTOR	ERJ3GEYJ 101 V (100 Ω)
R271	7030003320	S.RESISTOR	ERJ3GEYJ 101 V (100 Ω)
R285	7030003320	S.RESISTOR	ERJ3GEYJ 101 V (100 Ω)
R287	7030003560	S.RESISTOR	ERJ3GEYJ 103 V (10 kΩ)
R290	7030003420	S.RESISTOR	ERJ3GEYJ 681 V (680 Ω)
R291	7030003680	S.RESISTOR	ERJ3GEYJ 104 V (100 kΩ)
R297	7030005651	S.RESISTOR	ERA3YKD 304V (300 kΩ)
R298	7030005871	S.RESISTOR	ERA3YKD 104V (100 kΩ)
R304	7030003600	S.RESISTOR	ERJ3GEYJ 223 V (22 kΩ)
R310	7030003550	S.RESISTOR	ERJ3GEYJ 822 V (8.2 kΩ)
R311	7030003360	S.RESISTOR	ERJ3GEYJ 221 V (220 Ω)
R312	7030003720	S.RESISTOR	ERJ3GEYJ 224 V (220 kΩ)
R313	7030003800	S.RESISTOR	ERJ3GEYJ 105 V (1 MΩ)
R314	7030003680	S.RESISTOR	ERJ3GEYJ 104 V (100 kΩ)
R315	7030003680	S.RESISTOR	ERJ3GEYJ 104 V (100 kΩ)
R316	7030003440	S.RESISTOR	ERJ3GEYJ 102 V (1 kΩ)
R317	7030003440	S.RESISTOR	ERJ3GEYJ 102 V (1 kΩ)
R318	7030003520	S.RESISTOR	ERJ3GEYJ 472 V (4.7 kΩ)

[MAIN UNIT]

REF NO.	ORDER NO.	DESCRIPTION	
R319	7030003590	S.RESISTOR	ERJ3GEYJ 183 V (18 kΩ)
R320	7030003760	S.RESISTOR	ERJ3GEYJ 474 V (470 kΩ)
R321	7030003560	S.RESISTOR	ERJ3GEYJ 103 V (10 kΩ)
R322	7030003680	S.RESISTOR	ERJ3GEYJ 104 V (100 kΩ)
R323	7030005220	S.RESISTOR	ERJ2GEJ 223 X (22 kΩ)
R324	7030003680	S.RESISTOR	ERJ3GEYJ 104 V (100 kΩ)
R325	7030005120	S.RESISTOR	ERJ2GEJ 102 X (1 kΩ)
R326	7030005120	S.RESISTOR	ERJ2GEJ 102 X (1 kΩ)
R327	7030005120	S.RESISTOR	ERJ2GEJ 102 X (1 kΩ)
R328	7030004040	S.RESISTOR	ERJ3GEYJ 4R7 V (4.7 Ω)
R329	7030000440	S.RESISTOR	MCR10EZHZ 3.3 kΩ (A)
	7030000480	S.RESISTOR	MCR10EZHZ 6.8 kΩ (682) (B)
R330	7030003520	S.RESISTOR	ERJ3GEYJ 472 V (4.7 kΩ)
R331	7030003440	S.RESISTOR	ERJ3GEYJ 102 V (1 kΩ)
R332	7030003620	S.RESISTOR	ERJ3GEYJ 333 V (33 kΩ)
R333	7030003680	S.RESISTOR	ERJ3GEYJ 104 V (100 kΩ)
R334	7030003760	S.RESISTOR	ERJ3GEYJ 474 V (470 kΩ)
R335	7030003440	S.RESISTOR	ERJ3GEYJ 102 V (1 kΩ)
R336	7030003660	S.RESISTOR	ERJ3GEYJ 683 V (68 kΩ)
C1	4030011170	S.CERAMIC	GRM31M2C2H180JV01L (GRM42-6 CH)
C2	4030011180	S.CERAMIC	GRM31M2C2H220JV01L (GRM42-6 CH)
	4030011270	S.CERAMIC	GRM31M2C2H200JV01L (GRM42-6 CH)
C3	4030011340	S.CERAMIC	C1608 CH 1H 471J-T (A)
C4	4030007040	S.CERAMIC	C1608 CH 1H 180J-T (A)
	4030007030	S.CERAMIC	C1608 CH 1H 150J-T (B)
C5	4030011340	S.CERAMIC	C1608 CH 1H 471J-T
C6	4030011180	S.CERAMIC	GRM31M2C2H220JV01L (GRM42-6 CH)
	4030011270	S.CERAMIC	GRM31M2C2H200JV01L (GRM42-6 CH)
C7	4030011290	S.CERAMIC	GRM31M2C2H240JV01L (GRM42-6 CH)
	4030011170	S.CERAMIC	GRM31M2C2H180JV01L (GRM42-6 CH)
C8	4030011180	S.CERAMIC	GRM31M2C2H220JV01L (GRM42-6 CH)
	4030011270	S.CERAMIC	GRM31M2C2H200JV01L (GRM42-6 CH)
C9	4030011180	S.CERAMIC	GRM31M2C2H220JV01L (GRM42-6 CH)
	4030011270	S.CERAMIC	GRM31M2C2H200JV01L (GRM42-6 CH)
C10	4030006860	S.CERAMIC	C1608 JB 1H 102K-T
C11	4030006860	S.CERAMIC	C1608 JB 1H 102K-T
C12	4030011340	S.CERAMIC	C1608 CH 1H 471J-T
C13	4030007090	S.CERAMIC	C1608 CH 1H 470J-T
C14	4030017200	S.CERAMIC	GRM31BR32J102KY01L (GHM1030 R)
C15	4030008560	S.CERAMIC	C1608 CH 1H 300J-T
C17	4030007020	S.CERAMIC	C1608 CH 1H 120J-T
C18	4030011770	S.CERAMIC	C1608 CH 1H 060B-T
C19	4030006860	S.CERAMIC	C1608 JB 1H 102K-T
C20	4030006860	S.CERAMIC	C1608 JB 1H 102K-T
C21	4030009540	S.CERAMIC	C1608 CH 1H 1R5B-T
C22	4030009540	S.CERAMIC	C1608 CH 1H 1R5B-T
C25	4030011770	S.CERAMIC	C1608 CH 1H 060B-T
C26	4030006860	S.CERAMIC	C1608 JB 1H 102K-T
C27	4030006860	S.CERAMIC	C1608 JB 1H 102K-T
C28	4030006860	S.CERAMIC	C1608 JB 1H 102K-T
C29	4030009910	S.CERAMIC	C1608 CH 1H 040B-T
C30	4030007050	S.CERAMIC	C1608 CH 1H 220J-T
C31	4030011600	S.CERAMIC	C1608 JB 1E 104K-T
C32	4030006860	S.CERAMIC	C1608 JB 1H 102K-T
C33	4030011600	S.CERAMIC	C1608 JB 1E 104K-T
C34	4030017460	S.CERAMIC	ECU0EB1E102K
C35	4030017490	S.CERAMIC	C1608 JB 1A 105K-T
C36	4030006860	S.CERAMIC	C1608 JB 1H 102K-T
C37	4030006860	S.CERAMIC	C1608 JB 1H 102K-T
C38	4030006860	S.CERAMIC	C1608 JB 1H 102K-T
C39	4030006860	S.CERAMIC	C1608 JB 1H 102K-T
C40	4030009540	S.CERAMIC	C1608 CH 1H 1R5B-T
C41	4030007050	S.CERAMIC	C1608 CH 1H 220J-T
C42	4030006860	S.CERAMIC	C1608 JB 1H 102K-T
C43	4030006860	S.CERAMIC	C1608 JB 1H 102K-T
C44	4030009530	S.CERAMIC	C1608 CH 1H 030B-T
C45	4030006860	S.CERAMIC	C1608 JB 1H 102K-T
C48	4030007090	S.CERAMIC	C1608 CH 1H 470J-T

(A): [F110] (B): [F111] and [F121] (C): IC-F110 for [EUR] (D): IC-F110 for [GEN] (E): IC-F110 for 25 kHz (F): IC-F110 for 20 kHz

S.=Surface mount

[MAIN UNIT]

REF NO.	ORDER NO.	DESCRIPTION	
C49	4030007040	S.CERAMIC	C1608 CH 1H 180J-T
C50	4030006860	S.CERAMIC	C1608 JB 1H 102K-T
C51	4030006860	S.CERAMIC	C1608 JB 1H 102K-T
C52	4030007060	S.CERAMIC	C1608 CH 1H 270J-T
C53	4030006900	S.CERAMIC	C1608 JB 1H 103K-T
C54	4030006860	S.CERAMIC	C1608 JB 1H 102K-T
C55	4030009910	S.CERAMIC	C1608 CH 1H 040B-T
C56	4030007040	S.CERAMIC	C1608 CH 1H 180J-T
C57	4030006860	S.CERAMIC	C1608 JB 1H 102K-T
C58	4030006860	S.CERAMIC	C1608 JB 1H 102K-T
C59	4030006860	S.CERAMIC	C1608 JB 1H 102K-T
C60	4030006900	S.CERAMIC	C1608 JB 1H 103K-T
C61	4030007130	S.CERAMIC	C1608 CH 1H 101J-T
C62	4030007120	S.CERAMIC	C1608 CH 1H 820J-T
C63	4030017420	S.CERAMIC	ECJ0EC1H470J
C64	4030006860	S.CERAMIC	C1608 JB 1H 102K-T
C65	4030006860	S.CERAMIC	C1608 JB 1H 102K-T
C66	4030006860	S.CERAMIC	C1608 JB 1H 102K-T
C67	4030006860	S.CERAMIC	C1608 JB 1H 102K-T
C68	4030007130	S.CERAMIC	C1608 CH 1H 101J-T
C69	4030007140	S.CERAMIC	C1608 CH 1H 121J-T
C70	4030007140	S.CERAMIC	C1608 CH 1H 121J-T
C71	4030011600	S.CERAMIC	C1608 JB 1E 104K-T
C72	4030006860	S.CERAMIC	C1608 JB 1H 102K-T
C73	4030017490	S.CERAMIC	C1608 JB 1A 105K-T
C74	4030006860	S.CERAMIC	C1608 JB 1H 102K-T
C75	4550006050	S.TANTALUM	TEMSVA 0J 106M8L
C76	4030006900	S.CERAMIC	C1608 JB 1H 103K-T
C77	4030006860	S.CERAMIC	C1608 JB 1H 102K-T
C78	4030006860	S.CERAMIC	C1608 JB 1H 102K-T
C79	4030011810	S.CERAMIC	C1608 JB 1A 224K-T
C80	4030011600	S.CERAMIC	C1608 JB 1E 104K-T
C81	4030006860	S.CERAMIC	C1608 JB 1H 102K-T
C82	4030011270	S.CERAMIC	GRM31M2C2H200JV01L (GRM42-6 CH)
		(A)	
	4030011120	S.CERAMIC	GRM31M2C2H100JV01L (GRM42-6 CH)
		(B)	
C83	4030011180	S.CERAMIC	GRM31M2C2H220JV01L (GRM42-6 CH)
		(A)	
	4030011120	S.CERAMIC	GRM31M2C2H100JV01L (GRM42-6 CH)
		(B)	
C84	4030007090	S.CERAMIC	C1608 CH 1H 470J-T
C85	4030006860	S.CERAMIC	C1608 JB 1H 102K-T
C86	4030007090	S.CERAMIC	C1608 CH 1H 470J-T
C87	4030006860	S.CERAMIC	C1608 JB 1H 102K-T
C88	4030006860	S.CERAMIC	C1608 JB 1H 102K-T
C89	4030007040	S.CERAMIC	C1608 CH 1H 180J-T
C90	4030007040	S.CERAMIC	C1608 CH 1H 180J-T
C91	4510005750	S.ELECTROLYTIC	ECEV1EA220SP
C92	4030007030	S.CERAMIC	C1608 CH 1H 150J-T
C93	4030007030	S.CERAMIC	C1608 CH 1H 150J-T
		(A)	
	4030007020	S.CERAMIC	C1608 CH 1H 120J-T
		(B)	
C94	4030007090	S.CERAMIC	C1608 CH 1H 470J-T
C95	4030006860	S.CERAMIC	C1608 JB 1H 102K-T
C96	4030006860	S.CERAMIC	C1608 JB 1H 102K-T
C97	4030007090	S.CERAMIC	C1608 CH 1H 470J-T
C99	4030006860	S.CERAMIC	C1608 JB 1H 102K-T
C100	4030007010	S.CERAMIC	C1608 CH 1H 100D-T
C101	4030009540	S.CERAMIC	C1608 CH 1H 1R5B-T
C102	4030007010	S.CERAMIC	C1608 CH 1H 100D-T
C103	4030009530	S.CERAMIC	C1608 CH 1H 030B-T
C104	4030006860	S.CERAMIC	C1608 JB 1H 102K-T
C105	4030006860	S.CERAMIC	C1608 JB 1H 102K-T
C106	4030007090	S.CERAMIC	C1608 CH 1H 470J-T
C107	4030006860	S.CERAMIC	C1608 JB 1H 102K-T
C108	4030006900	S.CERAMIC	C1608 JB 1H 103K-T
C109	4030006860	S.CERAMIC	C1608 JB 1H 102K-T
C110	4030011340	S.CERAMIC	C1608 CH 1H 471J-T
C111	4030007090	S.CERAMIC	C1608 CH 1H 470J-T
C113	4030009560	S.CERAMIC	C1608 CH 1H R75B-T
C114	4030007070	S.CERAMIC	C1608 CH 1H 330J-T
C115	4030007070	S.CERAMIC	C1608 CH 1H 330J-T
C116	4030006900	S.CERAMIC	C1608 JB 1H 103K-T
C117	4030011340	S.CERAMIC	C1608 CH 1H 471J-T
C118	4030009500	S.CERAMIC	C1608 CH 1H 0R5B-T
C119	4030006860	S.CERAMIC	C1608 JB 1H 102K-T
C120	4030011340	S.CERAMIC	C1608 CH 1H 471J-T
C121	4030007040	S.CERAMIC	C1608 CH 1H 180J-T
C122	4030007070	S.CERAMIC	C1608 CH 1H 330J-T
C123	4030007110	S.CERAMIC	C1608 CH 1H 680J-T

(A): [F110] (B): [F111] and [F121] (C): IC-F110 for [EUR]
 (D): IC-F110 for [GEN] (E): IC-F110 for 25 kHz (F): IC-F110 for 20 kHz

[MAIN UNIT]

REF NO.	ORDER NO.	DESCRIPTION	
C124	4030011280	S.CERAMIC	C1608 CH 1H 271J-T
C126	4030007070	S.CERAMIC	C1608 CH 1H 330J-T
C127	4030007030	S.CERAMIC	C1608 CH 1H 150J-T
C129	4030009510	S.CERAMIC	C1608 CH 1H 010B-T
C131	4030009510	S.CERAMIC	C1608 CH 1H 010B-T
C132	4030011600	S.CERAMIC	C1608 JB 1E 104K-T
C133	4610001590	S.TRIMMER	TZC3R100A110R00
C134	4610001590	S.TRIMMER	TZC3R100A110R00
C135	4030006860	S.CERAMIC	C1608 JB 1H 102K-T
C136	4030009530	S.CERAMIC	C1608 CH 1H 030B-T
C138	4030007090	S.CERAMIC	C1608 CH 1H 470J-T
C139	4030011600	S.CERAMIC	C1608 JB 1E 104K-T
C140	4030011600	S.CERAMIC	C1608 JB 1E 104K-T
C141	4030006860	S.CERAMIC	C1608 JB 1H 102K-T
C142	4030006860	S.CERAMIC	C1608 JB 1H 102K-T
C143	4030006860	S.CERAMIC	C1608 JB 1H 102K-T
C144	4030007090	S.CERAMIC	C1608 CH 1H 470J-T
C145	4030010760	S.CERAMIC	C1608 CH 1H 331J-T
C146	4550006150	S.TANTALUM	ECST1CY105R
C147	4550006390	S.TANTALUM	TEMSVA 1C 335M-8L
C148	4510004630	S.ELECTROLYTIC	ECEV1CA100SR
C149	4550000550	S.TANTALUM	TESVA 1V 224M1-8L
C151	4030011600	S.CERAMIC	C1608 JB 1E 104K-T
C152	4030007090	S.CERAMIC	C1608 CH 1H 470J-T
C153	4030007090	S.CERAMIC	C1608 CH 1H 470J-T
C154	4030007090	S.CERAMIC	C1608 CH 1H 470J-T
C155	4030011280	S.CERAMIC	C1608 CH 1H 271J-T
C156	4030007090	S.CERAMIC	C1608 CH 1H 470J-T
C157	4030007130	S.CERAMIC	C1608 CH 1H 101J-T
C158	4030007130	S.CERAMIC	C1608 CH 1H 101J-T
C160	4030007000	S.CERAMIC	C1608 CH 1H 090D-T
C161	4030007130	S.CERAMIC	C1608 CH 1H 101J-T
C162	4030006900	S.CERAMIC	C1608 JB 1H 103K-T
C163	4510004630	S.ELECTROLYTIC	ECEV1CA100SR
C164	4030006900	S.CERAMIC	C1608 JB 1H 103K-T
C165	4030006900	S.CERAMIC	C1608 JB 1H 103K-T
C166	4030006900	S.CERAMIC	C1608 JB 1H 103K-T
C167	4030008920	S.CERAMIC	C1608 JB 1H 473K-T
C168	4030008920	S.CERAMIC	C1608 JB 1H 473K-T
C169	4030008920	S.CERAMIC	C1608 JB 1H 473K-T
C170	4030006860	S.CERAMIC	C1608 JB 1H 102K-T
C172	4030009630	S.CERAMIC	C1608 JB 1H 822K-T
C173	4030011600	S.CERAMIC	C1608 JB 1E 104K-T
C174	4510004630	S.ELECTROLYTIC	ECEV1CA100SR
C175	4030006860	S.CERAMIC	C1608 JB 1H 102K-T
C176	4030007090	S.CERAMIC	C1608 CH 1H 470J-T
C177	4030008770	S.CERAMIC	C1608 JB 1H 562K-T
C178	4030007150	S.CERAMIC	C1608 CH 1H 151J-T
C179	4030011600	S.CERAMIC	C1608 JB 1E 104K-T
C180	4510004640	S.ELECTROLYTIC	ECEV1CA470SP
C181	4030011600	S.CERAMIC	C1608 JB 1E 104K-T
C182	4030008770	S.CERAMIC	C1608 JB 1H 562K-T
C183	4030011600	S.CERAMIC	C1608 JB 1E 104K-T
C184	4030009580	S.CERAMIC	C1608 JB 1H 681K-T
C200	4030011600	S.CERAMIC	C1608 JB 1E 104K-T
C201	4030016930	S.CERAMIC	ECJ0EB1A104K
C202	4030016930	S.CERAMIC	ECJ0EB1A104K
C203	4030016930	S.CERAMIC	ECJ0EB1A104K
C204	4030017420	S.CERAMIC	ECJ0EC1H470J
C207	4030017460	S.CERAMIC	ECJ0EB1E102K
C208	4030017460	S.CERAMIC	ECJ0EB1E102K
C209	4030017460	S.CERAMIC	ECJ0EB1E102K
C210	4030017460	S.CERAMIC	ECJ0EB1E102K
C226	4030017420	S.CERAMIC	ECJ0EC1H470J
C244	4030017480	S.CERAMIC	C1608 JB 1A 474K-T
C245	4030006900	S.CERAMIC	C1608 JB 1H 103K-T
C246	4030011600	S.CERAMIC	C1608 JB 1E 104K-T
C248	4030006860	S.CERAMIC	C1608 JB 1H 102K-T
C249	4030006870	S.CERAMIC	C1608 JB 1H 222K-T
C250	4030011600	S.CERAMIC	C1608 JB 1E 104K-T
C251	4030011600	S.CERAMIC	C1608 JB 1E 104K-T
C252	4030011600	S.CERAMIC	C1608 JB 1E 104K-T
C253	4030008880	S.CERAMIC	C1608 JB 1H 223K-T
C254	4030006860	S.CERAMIC	C1608 JB 1H 102K-T
C255	4510008030	S.ELECTROLYTIC	ECEV1EA471P
C256	4510006260	S.ELECTROLYTIC	ECEV1AA471UP
C258	4510008030	S.ELECTROLYTIC	ECEV1EA471P
C259	4030006860	S.CERAMIC	C1608 JB 1H 102K-T
C260	4030007090	S.CERAMIC	C1608 CH 1H 470J-T
C261	4030004760	S.CERAMIC	C2012 JF 1H 104Z-T
C262	4030011600	S.CERAMIC	C1608 JB 1E 104K-T
C263	4030004760	S.CERAMIC	C2012 JF 1H 104Z-T

S.=Surface mount

[MAIN UNIT]

REF NO.	ORDER NO.	DESCRIPTION
C264	4030011600	S.CERAMIC C1608 JB 1E 104K-T
C265	4510008030	S.ELECTROLYTIC ECEV1EA471P
C266	4510004630	S.ELECTROLYTIC ECEV1CA100SR
C268	4550006700	S.TANTALUM ECST1AY106R
C269	4030006860	S.CERAMIC C1608 JB 1H 102K-T
C270	4030006860	S.CERAMIC C1608 JB 1H 102K-T
C271	4510004630	S.ELECTROLYTIC ECEV1CA100SR
C272	4510004630	S.ELECTROLYTIC ECEV1CA100SR
C273	4030006860	S.CERAMIC C1608 JB 1H 102K-T
C274	4510004630	S.ELECTROLYTIC ECEV1CA100SR
C275	4030006860	S.CERAMIC C1608 JB 1H 102K-T
C276	4030006860	S.CERAMIC C1608 JB 1H 102K-T
C280	4030006900	S.CERAMIC C1608 JB 1H 103K-T
C282	4030011600	S.CERAMIC C1608 JB 1E 104K-T
C283	4030006860	S.CERAMIC C1608 JB 1H 102K-T
C286	4030006900	S.CERAMIC C1608 JB 1H 103K-T
C287	4030008650	S.CERAMIC C1608 JB 1H 332K-T
C288	4030011600	S.CERAMIC C1608 JB 1E 104K-T
C289	4030011600	S.CERAMIC C1608 JB 1E 104K-T
C290	4030006860	S.CERAMIC C1608 JB 1H 102K-T
C291	4030006860	S.CERAMIC C1608 JB 1H 102K-T
C292	4030007090	S.CERAMIC C1608 CH 1H 470J-T
C293	4030006860	S.CERAMIC C1608 JB 1H 102K-T
C294	4030006860	S.CERAMIC C1608 JB 1H 102K-T
C295	4510004630	S.ELECTROLYTIC ECEV1CA100SR
C297	4030007050	S.CERAMIC C1608 CH 1H 220J-T
C298	4030007020	S.CERAMIC C1608 CH 1H 120J-T
C299	4030007020	S.CERAMIC C1608 CH 1H 120J-T
C300	4030007010	S.CERAMIC C1608 CH 1H 100D-T
C301	4030006860	S.CERAMIC C1608 JB 1H 102K-T
C302	4030007010	S.CERAMIC C1608 CH 1H 100D-T
C303	4030006860	S.CERAMIC C1608 JB 1H 102K-T
C304	4030007010	S.CERAMIC C1608 CH 1H 100D-T
C305	4030007100	S.CERAMIC C1608 CH 1H 560J-T
C306	4030009910	S.CERAMIC C1608 CH 1H 040B-T
C307	4030006980	S.CERAMIC C1608 CH 1H 070D-T
C308	4030009530	S.CERAMIC C1608 CH 1H 030B-T
C309	4030006900	S.CERAMIC C1608 JB 1H 103K-T
C310	4030006860	S.CERAMIC C1608 JB 1H 102K-T
C311	4030006860	S.CERAMIC C1608 JB 1H 102K-T
C312	4030011600	S.CERAMIC C1608 JB 1E 104K-T
C314	4030006900	S.CERAMIC C1608 JB 1H 103K-T
C315	4030008880	S.CERAMIC C1608 JB 1H 223K-T
C316	4030009490	S.CERAMIC C1608 JB 1H 821K-T
C317	4030009490	S.CERAMIC C1608 JB 1H 821K-T
C318	4030011600	S.CERAMIC C1608 JB 1E 104K-T
C320	4030008910	S.CERAMIC C1608 JB 1H 393K-T
C321	4030011600	S.CERAMIC C1608 JB 1E 104K-T
C322	4030006900	S.CERAMIC C1608 JB 1H 103K-T
C324	4030011340	S.CERAMIC C1608 CH 1H 471J-T
C325	4030006860	S.CERAMIC C1608 JB 1H 102K-T
C327	4510004630	S.ELECTROLYTIC ECEV1CA100SR
C330	4550006170	S.TANTALUM ECST1AY225R
C331	4030006860	S.CERAMIC C1608 JB 1H 102K-T
C332	4550006700	S.TANTALUM ECST1AY106R
C333	4030007090	S.CERAMIC C1608 CH 1H 470J-T
C335	4030006860	S.CERAMIC C1608 JB 1H 102K-T
C337	4030006860	S.CERAMIC C1608 JB 1H 102K-T
C339	4030009550	S.CERAMIC C1608 CH 1H 2R5B-T
C342	4550006410	S.TANTALUM ECST1VY334R
C343	4030006900	S.CERAMIC C1608 JB 1H 103K-T
C348	4030006860	S.CERAMIC C1608 JB 1H 102K-T
C349	4030011600	S.CERAMIC C1608 JB 1E 104K-T
C350	4030017490	S.CERAMIC C1608 JB 1A 105K-T
C351	4030008920	S.CERAMIC C1608 JB 1H 473K-T
C352	4510005750	S.ELECTROLYTIC ECEV1EA220SP
C353	4030011770	S.CERAMIC C1608 CH 1H 060B-T
C355	4030006990	S.CERAMIC C1608 CH 1H 080D-T
C356	4030006990	S.CERAMIC C1608 CH 1H 080D-T
C357	4030011600	S.CERAMIC C1608 JB 1E 104K-T
C359	4030017490	S.CERAMIC C1608 JB 1A 105K-T
C360	4030009920	S.CERAMIC C1608 CH 1H 050B-T
C361	4030016930	S.CERAMIC ECJ0EB1A104K
C362	4030006860	S.CERAMIC C1608 JB 1H 102K-T
C363	4030011600	S.CERAMIC C1608 JB 1E 104K-T
C364	4030006850	S.CERAMIC C1608 JB 1H 471K-T
C372	4030006850	S.CERAMIC C1608 JB 1H 471K-T
C375	4030006860	S.CERAMIC C1608 JB 1H 102K-T
C376	4030009910	S.CERAMIC C1608 CH 1H 040B-T
C378	4030010020	S.CERAMIC C1608 JB 1H 122K-T
C379	4030006900	S.CERAMIC C1608 JB 1H 103K-T

[MAIN UNIT]

REF NO.	ORDER NO.	DESCRIPTION
C380	4030007050	S.CERAMIC C1608 CH 1H 220J-T (A)
	4030007040	S.CERAMIC C1608 CH 1H 180J-T (B)
C381	4030007050	S.CERAMIC C1608 CH 1E 220J-T (A)
	4030009650	S.CERAMIC C1608 CH 1H 240J-T (B)
C382	4030007170	S.CERAMIC C1608 CH 1H 221J-T
C383	4030011600	S.CERAMIC C1608 JB 1E 104K-T
C384	4030011600	S.CERAMIC C1608 JB 1E 104K-T
C385	4030011600	S.CERAMIC C1608 JB 1E 104K-T
C508	4030011170	S.CERAMIC GRM31M2C2H180JV01L (GRM42-6 CH)
C509	4030011600	S.CERAMIC C1608 JB 1E 104K-T
C510	4030007030	S.CERAMIC C1608 CH 1H 150J-T (A) only
C511	4030009570	S.CERAMIC C1608 CH 1H 0R3B-T (B) only
C512	4030006860	S.CERAMIC C1608 JB 1H 102K-T (B) only
C513	4030011120	S.CERAMIC GRM31M2C2H100JV01L (GRM42-6 CH) (B) only
C514	4030011120	S.CERAMIC GRM31M2C2H100JV01L (GRM42-6 CH) (B) only
C515	4030006860	S.CERAMIC C1608 JB 1H 102K-T (B) only
J1	6510018430	S.CONNECTOR AXN330C038P
J2	6510022470	S.CONNECTOR 40FLT-SM1-TB
J4	6450000140	CONNECTOR HSJ0807-01-010
J6	6510019250	S.CONNECTOR B11B-ZR-SM3-TF
J7	6510014960	S.CONNECTOR B2B-ZR-SM3-TF
W1	7120000470	JUMPER ERDS2T0
W2	8900011861	CABLE OPC-1195A <CMI>
W4	7030003860	S.JUMPER ERJ3GE JPW V
W6	7030010040	S.JUMPER ERJ2GE-JPW
W7	7030010040	S.JUMPER ERJ2GE-JPW
W8	7030010040	S.JUMPER ERJ2GE-JPW
W9	7030010040	S.JUMPER ERJ2GE-JPW
W10	7030003860	S.JUMPER ERJ3GE JPW V
W11	7030003860	S.JUMPER ERJ3GE JPW V (B) only
W12	7030003860	S.JUMPER ERJ3GE JPW V (B) only
EP1	6910013370	S.BEAD BLM18BB221SN1D (BLM11B221SB)
EP2	6910011560	BEAD HF70BB4.5X5X1.6
EP3	6910011560	BEAD HF70BB4.5X5X1.6
EP4	6910010280	BEAD HF70BB9.5X10.4X4.9
EP5	6910010280	BEAD HF70BB9.5X10.4X4.9
EP6	0910055673	PCB B 5909C

(A): [F110] (B): [F111] and [F121] (C): IC-F110 for [EUR]
 (D): IC-F110 for [GEN] (E): IC-F110 for 25 kHz (F): IC-F110 for 20 kHz

S.=Surface mount

SECTION 7 MECHANICAL PARTS AND DISASSEMBLY

[CHASSIS PARTS]

REF. NO.	ORDER NO.	DESCRIPTION	QTY.
J1	6510004880	Connector MR-DS-E 01	1
MP1	8010019060	2601 chassis	1
MP2	8110007820	2601 cover	1
MP3	8210019340	2622 front panel	1
MP4	8930059010	2622 keyboard	1
MP5	8930059090	2622 LCD plate	1
MP6	8210019350	2622 reflector	1
MP7	8610011180	Knob N292	1
MP9	8810008660	Screw PH BT M3 × 8 NI-ZU	8
MP10	8810008660	Screw PH BT M3 × 8 NI-ZU	2
MP11	8810008660	Screw PH BT M3 × 8 NI-ZU	2
MP12	8810008760	Screw PH BT M3 × 8 NI-ZU	3
MP13	8810008660	Screw PH BT M3 × 8 NI-ZU	1
MP14	8810009990	Screw PH BT M3 × 8 ZK	4
MP15	8810009990	Screw PH BT M3 × 8 ZK	2
MP16	8930059100	2622 LCD filter	1
MP17	8930059000	2601 SP net	1

[ACCESSORIES]

REF. NO.	ORDER NO.	DESCRIPTION	QTY.
MC1	0800005780	Microphone HM-100N	1
W1	8900011780	Cable OPC-1194	1
W2	8900000730	Cable OPC-049	1
MP1	8010019170	2601 mobil bracket assembly	1
MP3	8820000530	Flange bolt M4 × 8 NI	4
MP4	8810000470	Screw PH M5 × 12 (+)	4
MP5	8810005840	Screw PH A M5 × 20	4
MP6	8850000150	Flat washer M5 NI BS	4
MP7	8850000390	Spring washer M5	4
MP8	8830000120	Nut M5	4
MP9	6910004210	731 mic hanger set	1
MP10	8310054770	1705 LCD seal (F)	1

Screw abbreviations A,BT: Self-tapping PH: Pan head
 ZK: Black BS: Brass
 NI: Nickel NI-ZU: Nickel-Zinc

[FRONT UNIT]

REF. NO.	ORDER NO.	DESCRIPTION	QTY.
R14	7210003020	Variable resistor EVU-F2KFK1 B14	1
SP1	2510001220	Speaker C052SB500-13	1
J1	6450002210	Connector 3017-8821	1
W1	8900010500	Cable OPC-1046	1
DS11	5030002510	LCD L2-0607TAY	1
EP2	8930059170	LCD contact SRCN-2622-SP-N-W	1
MP1	8930059110	2622 spring	1

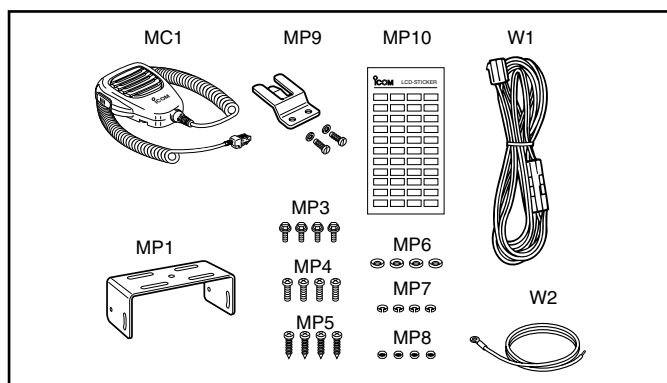

[MAIN UNIT]

REF. NO.	ORDER NO.	DESCRIPTION	QTY.
J4	6450000140	Connector HSJ0807-01-010	1
W2	8900011861	Cable OPC-1195A	1
MP1	8510002280	VCO shield plate (A)	1
MP4	8510014940	2601 VCO case	1
MP5	8510014950	2601 VCO cover	1
MP6	8510014910	2601 filter case	1
MP7	8510015110	2602 M-plate	1
MP9	8930058990	Shield sponge (V)	1
MP10	8930058840	Shield sponge (T) [GEN] only	1
MP11	8930058840	Shield sponge (T)	1

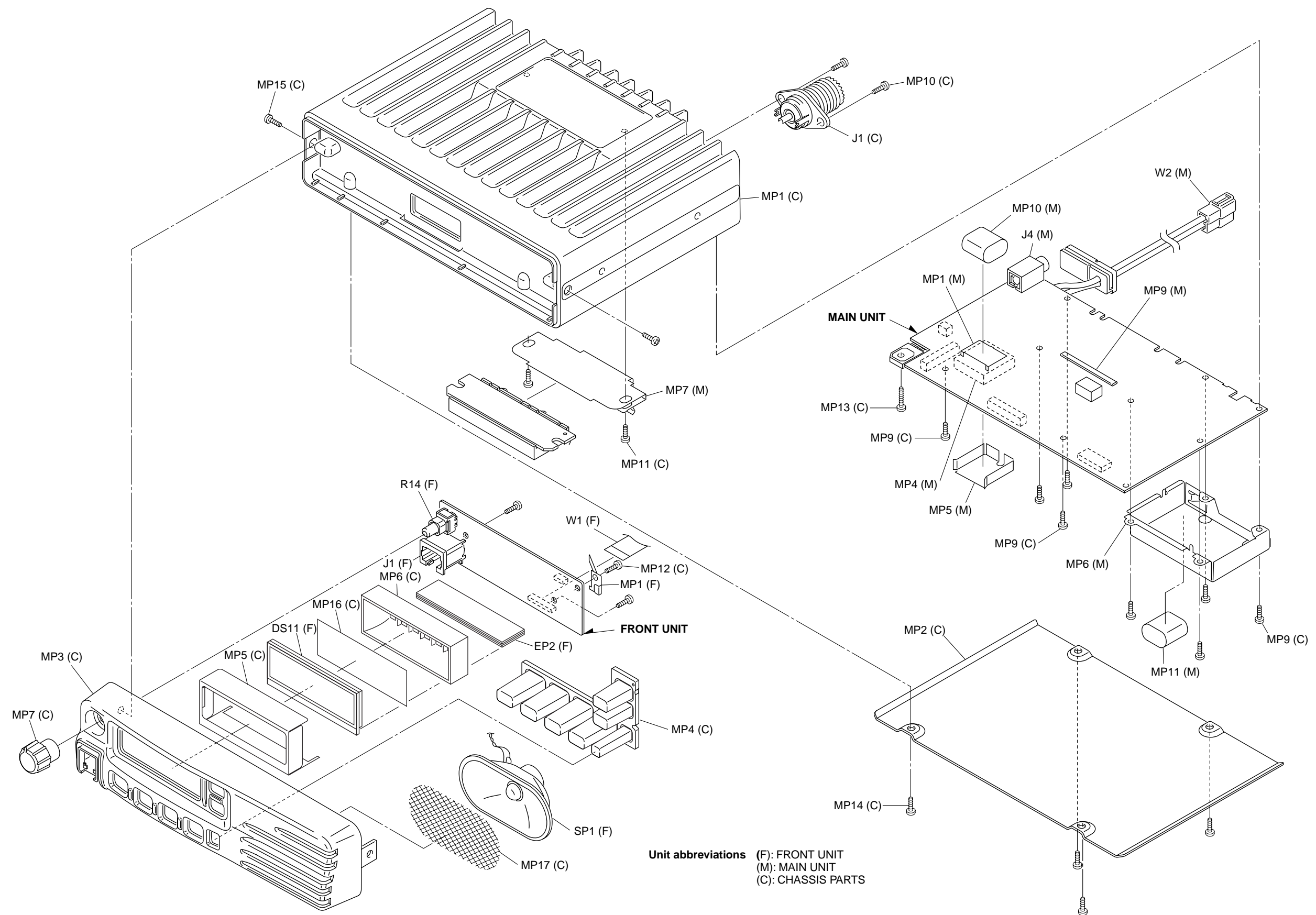

SECTION 8 SEMI-CONDUCTOR INFORMATION

• TRANSISTORS AND FET'S

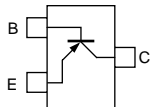
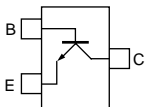
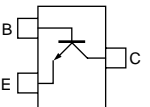
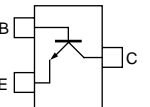
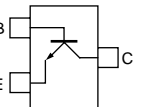
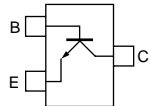
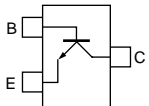
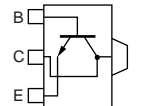
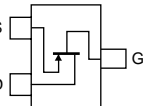
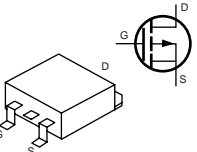
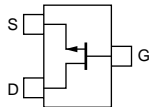
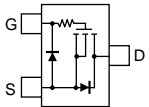
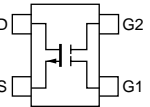
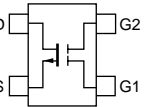
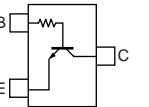
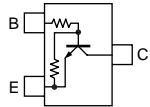
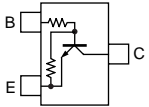
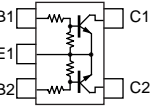
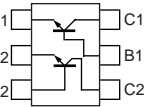
2SA1577 T106 Q (Symbol: HQ) 	2SC3356 T1B R25 (Symbol: R25) 	2SC4116 BL (Symbol: LL) 	2SC4213 B (Symbol: AB) 	2SC4215 O (Symbol: QO) 
2SC4226 T1 R25 (Symbol: R25) 	2SC5107 O (Symbol: MFO) 	2SD1664 T100Q (Symbol: DAQ) 	2SJ144 GR (Symbol: VG) 	2SJ377 (Symbol: 4L) 
2SK880 Y (Symbol: XY) 	2SK1829 (Symbol: K1) 	3SK293 (Symbol: UF) 	3SK299 T1 U73 (Symbol: U73) 	DTC114TUA T106 (Symbol: 04) 
DTC144EUA T106 (Symbol: 26) 	DTC363 EK (Symbol: H27) 	XP1214 (Symbol: 9H) 	XP6501 AB (Symbol: 5N) 	

• DIODES

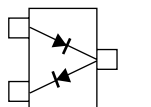
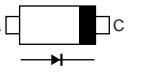
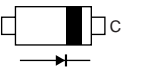
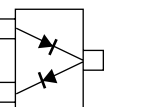
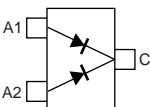
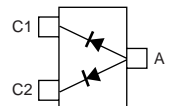
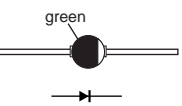
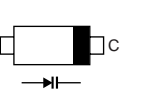
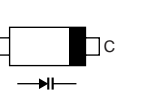
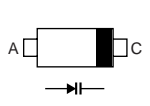
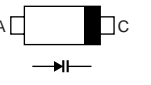
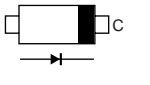
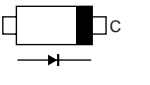
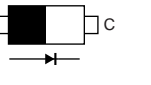
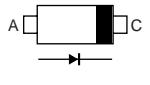
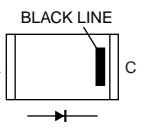
1SS375-TL (Symbol: FH) 	1SV239 (Symbol: TC) 	1SV307 (Symbol: TX) 	DA221 TL (Symbol: K) 	DAN222TL (Symbol: N) 
DAP222 (Symbol: P) 	DSA3A1 (Symbol: Green) 	HVC350B (Symbol: B0) 	HVC362 (Symbol: V2) 	HVC375B (Symbol: B8) 
HVC376B (Symbol: B9) 	MA2S111 (Symbol: A) 	MA2S728 (Symbol: B) 	MA77 (Symbol: 4B) 	MA8056 M (Symbol: 5-6) 
UM9401F (Symbol: none) 				

SECTION 9 BOARD LAYOUTS

9-1 FRONT UNIT • TOP VIEW

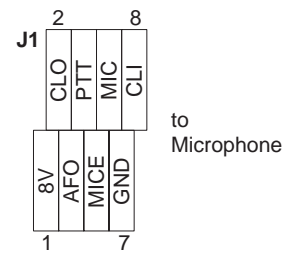
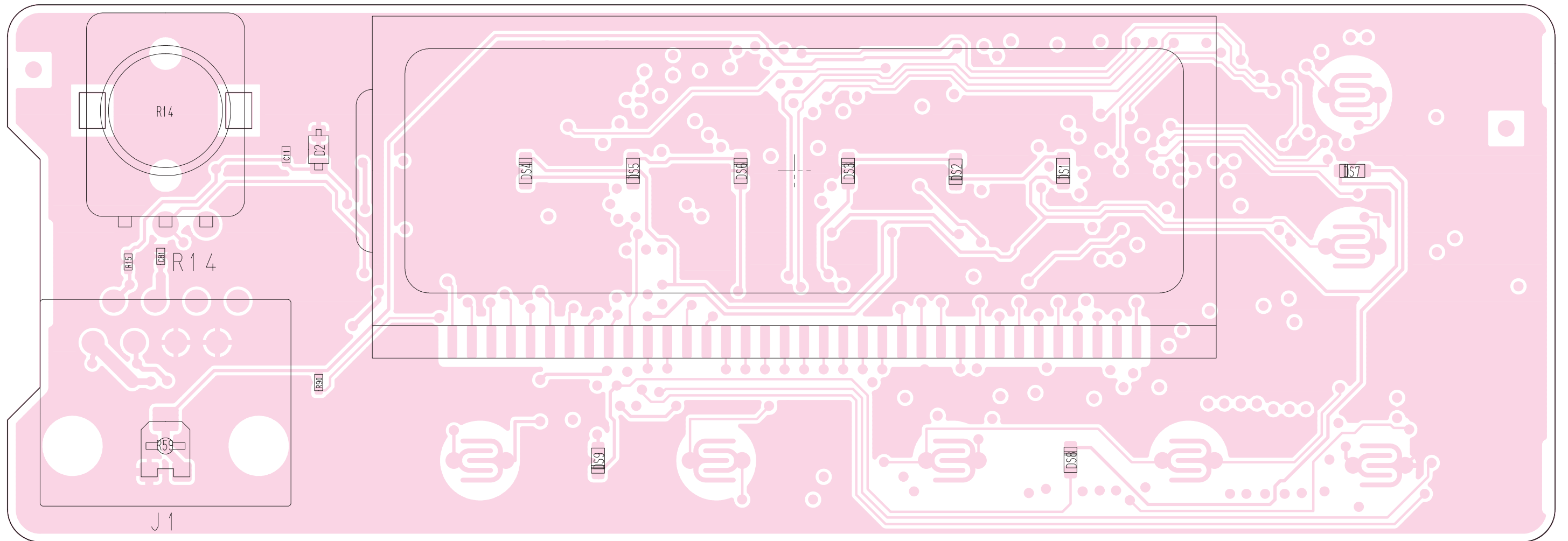

• BOTTOM VIEW (FRONT UNIT)

14	GND	2
GND	GND	
GND	GND	
PWON	NMI	
OPT1	RES	
P87	OPT2	
P86	NC	
CPU5V		
13		1

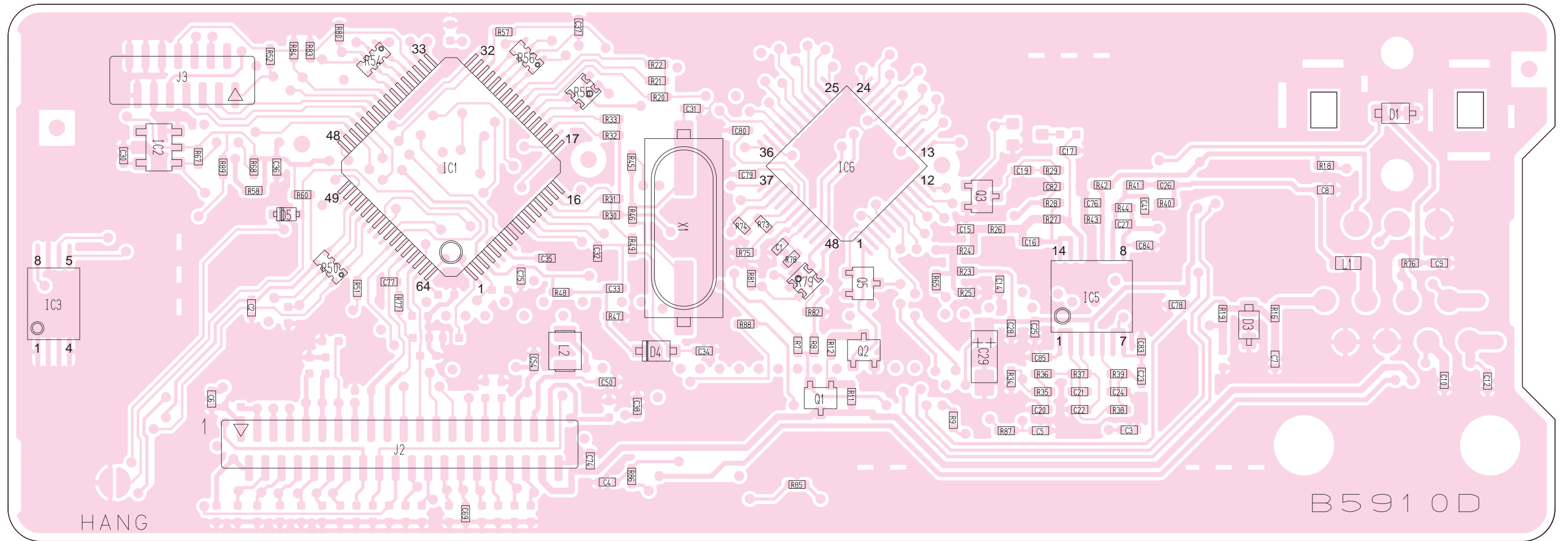

HANG

B5910D

1	GND	39
TONE	TENC	
NOIS	EXOE	
EXST	UNLK	
PLST	CDEC	
SDEC	OV12	
RSSI	LVIN	
TEMP	BATV	
NC	NC	
NC	5V	
CPU5	8V	
AFO	GND	
2		40

to MAIN unit J2

9-2 MAIN UNIT
• TOP VIEW

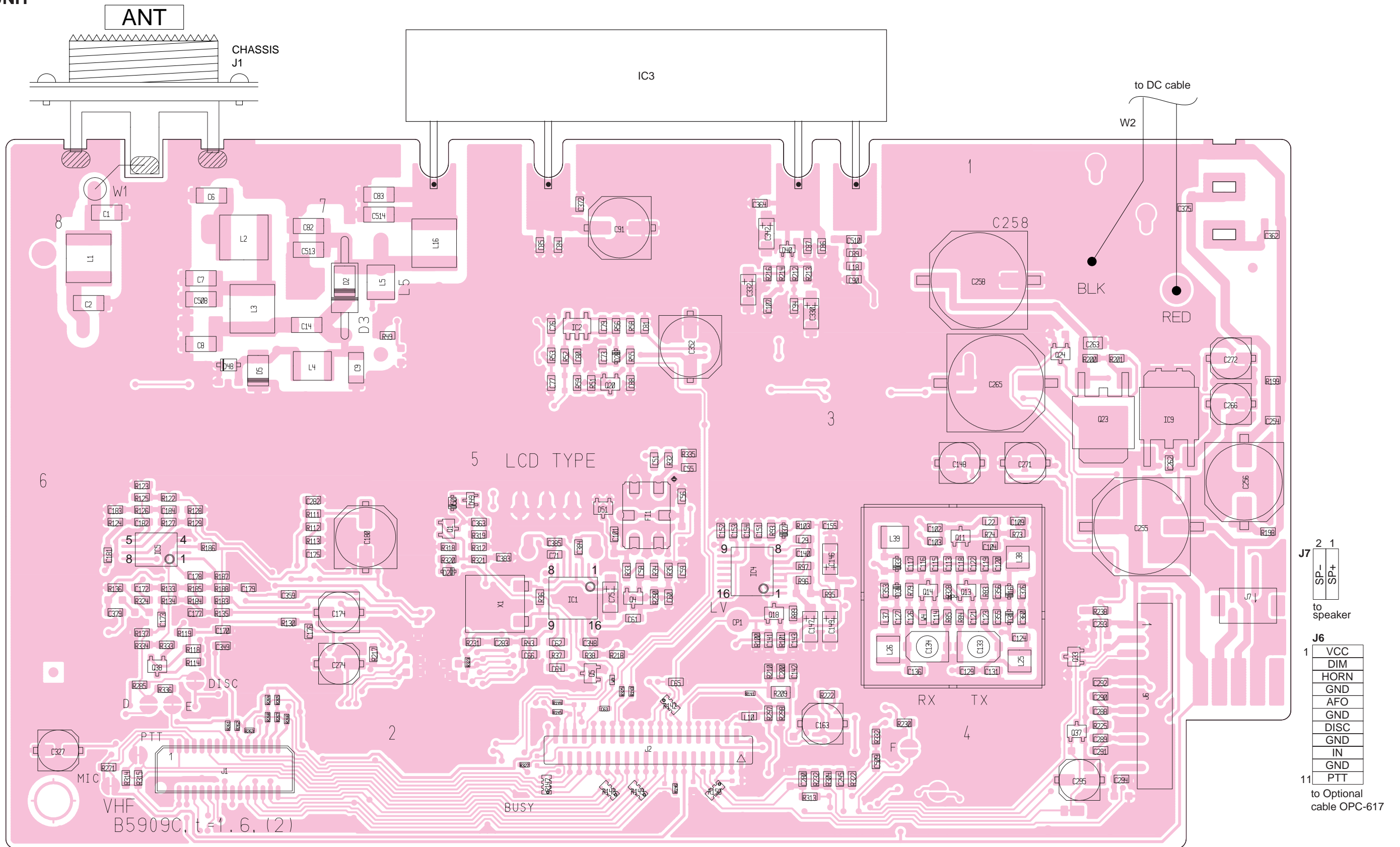

1	PTTI	15
2	PTTO	
3	MCOT	
4	MCIN	
5	NC	
6	AFONO	
7	BEEPO	
8	BUSY	
9	NC	
10	RMUTE	
11	NC	
12	SIGO	
13	DET	
14	DISC	
15	OPT1	
16	REM	
17	OPT2	
18	OPT3	
19	CCS	
20	GND	
21	CIRQ	
22	DAST	
23	SO	
24	SI	
25	OV12	
26	SCK	
27	OV12	
28		
29		
30		

to Optional unit

40	GND	2
39	TONE	
38	TENC	
37	NOIS	
36	EXOE	
35	EXST	
34	UNLK	
33	PLST	
32	REEM	
31	SCK	
30	CDEC	
29	SDEC	
28	SI	
27	OV12	
26	RSSI	
25	LVIN	
24	CCS	
23	MIC	
22	TEMP	
21	BATV	
20	NC	
19	NC	
18	BEEP	
17	PWON	
16	5V	
15	CPU5	
14	8V	
13	AFO	
12	GND	
11		
10		
9		
8		
7		
6		
5		
4		
3		
2		

to FRONT unit J2

2	SP-	1
1	SP+	

to speaker

11	VCC
10	DIM
9	HORN
8	GND
7	AFO
6	GND
5	DISC
4	GND
3	IN
2	GND
1	PTT

to Optional cable OPC-617

SECTION 10 BLOCK DIAGRAM

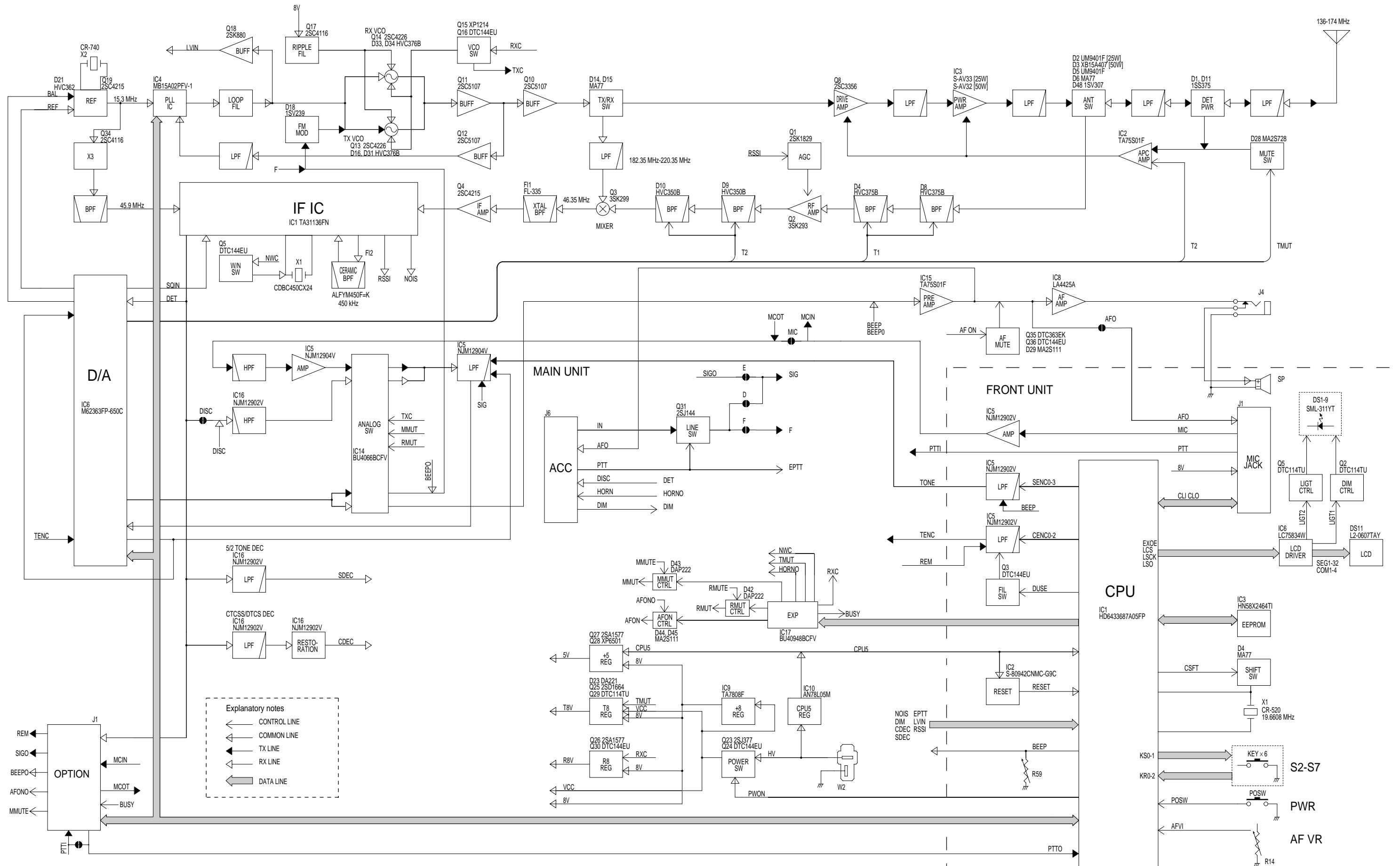

SECTION 11 VOLTAGE DIAGRAMS

11-1 FRONT UNIT

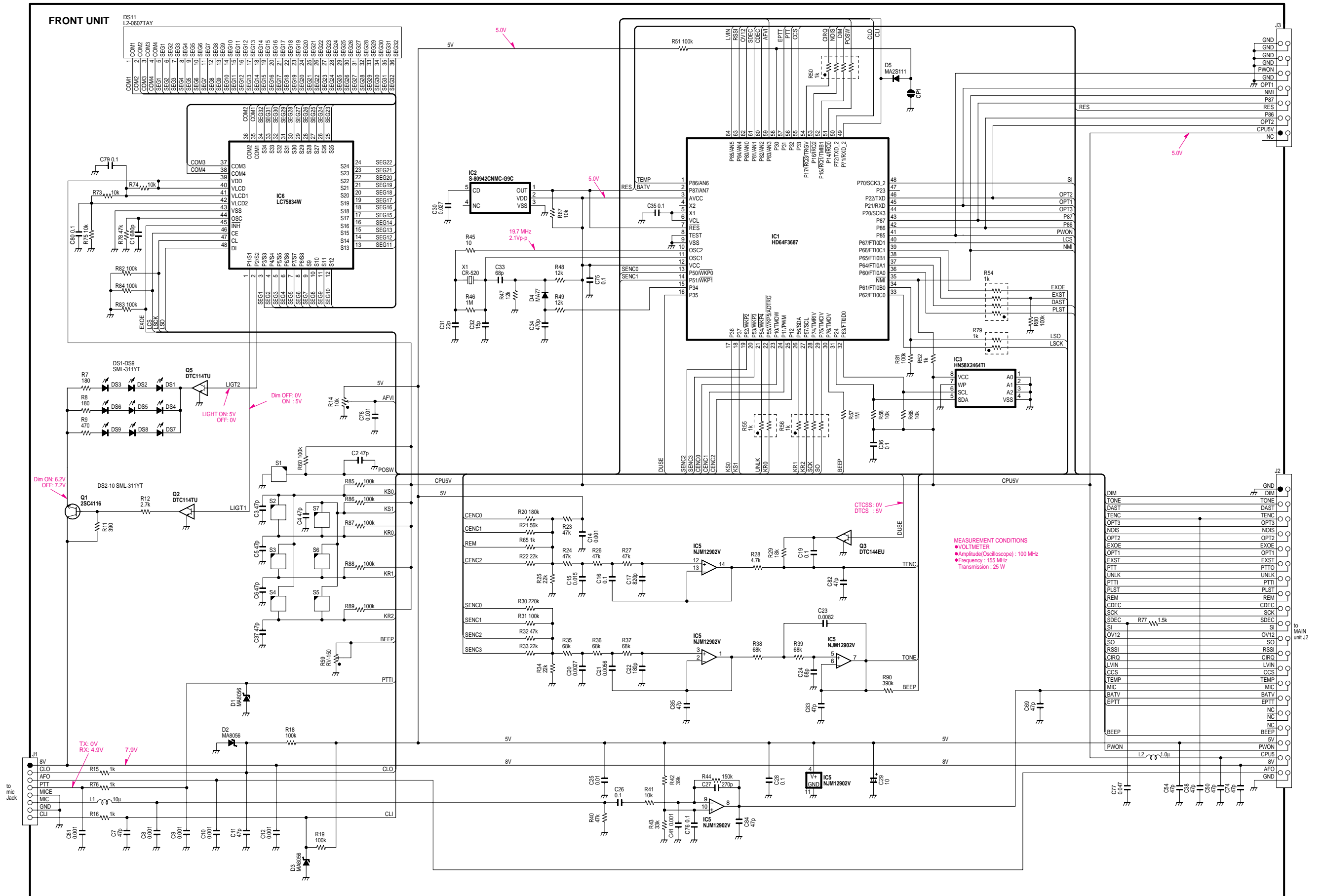

11-2 MAIN UNIT

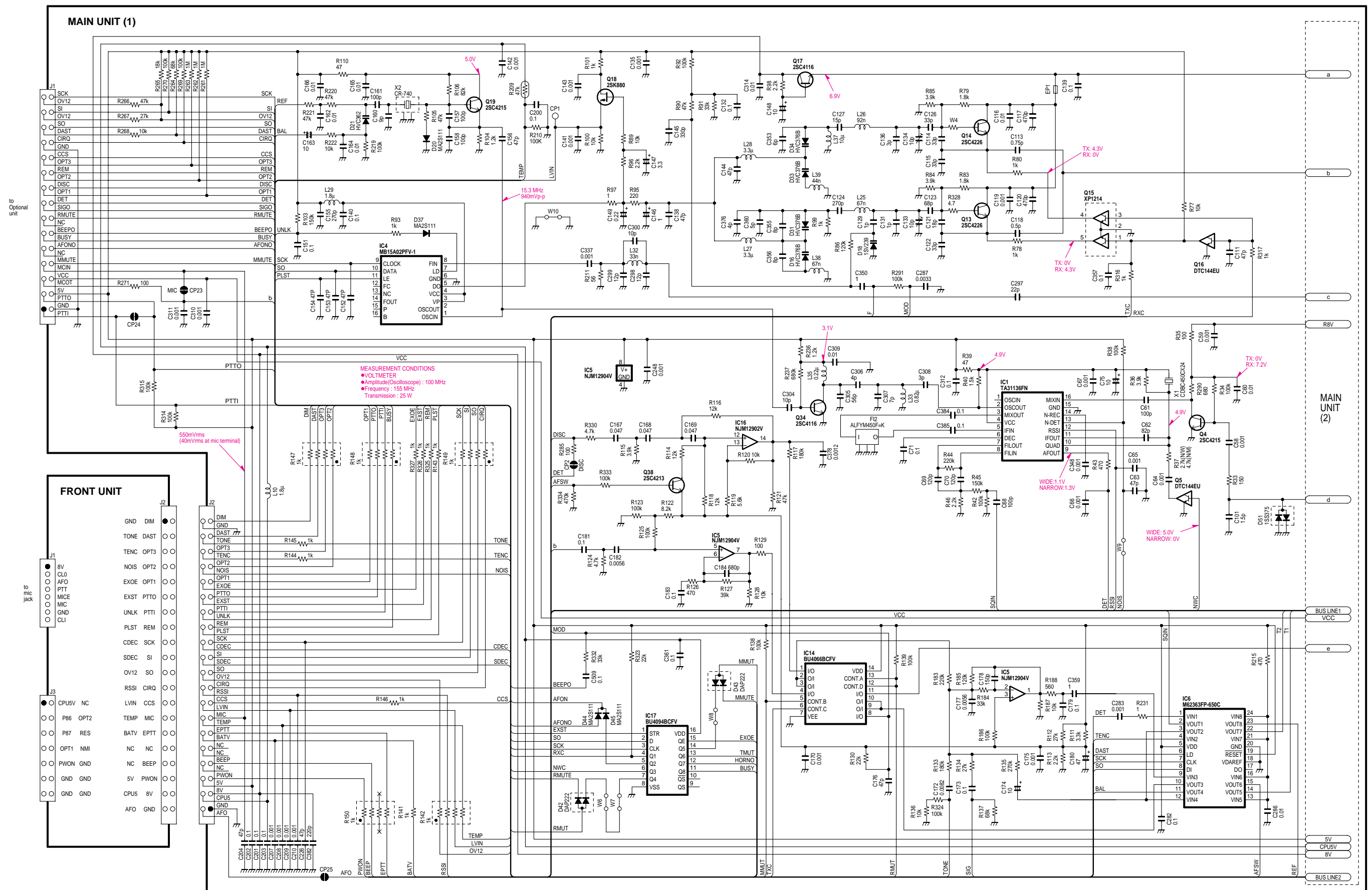

Icom Inc.

1-1-32, Kamiminami, Hirano-ku, Osaka 547-0003, Japan
Phone : 06 6793 5302
Fax : 06 6793 0013
URL : <http://www.icom.co.jp/world/index.html>

Icom America Inc.

<Corporate Headquarters>
2380 116th Avenue N.E., Bellevue, WA 98004, U.S.A.
Phone : (425) 454-8155 Fax : (425) 454-1509
URL : <http://www.icomamerica.com>
<Customer Service>
Phone : (425) 454-7619

Icom Canada

Glenwood Centre #150-6165
Highway 17 Delta, B.C., V4K 5B8, Canada
Phone : (604) 952-4266 Fax : (604) 952-0090
URL : <http://www.icomcanada.com>

Icom (Australia) Pty. Ltd.

A.B.N. 88 006 092 575
290-294 Albert Street, Brunswick, Victoria, 3056, Australia
Phone : 03 9387 0666 Fax : 03 9387 0022
URL : <http://www.icom.net.au>

Icom New Zealand

146A Harris Road, East Tamaki,
Auckland, New Zealand
Phone : 09 274 4062 Fax : 09 274 4708
URL : <http://www.icom.co.nz>

Beijing Icom Ltd.

1305, Wanshang Plaza, Shijingshan Road, Beijing China
Phone : (010) 6866 6337 Fax : (010) 6866 3553
URL : <http://www.bjicom.com>

Icom (Europe) GmbH

Communication Equipment
Himmelgeister Str. 100, D-40225 Düsseldorf, Germany
Phone : 0211 346047 Fax : 0211 333639
URL : <http://www.icomeurope.com>

Icom Spain S.L

Crta. de Gracia a Manresa Km. 14,750
08190 Sant Cugat del Valles Barcelona, SPAIN
Phone : (93) 590 26 70 Fax : (93) 589 04 46
URL : <http://www.icomspain.com>

Icom (UK) Ltd.

Unit 9, Sea St., Herne Bay, Kent, CT6 8LD, U.K.
Phone : 01227 741741 Fax : 01227 741742
URL : <http://www.icomuk.co.uk>

Icom France S.a

Zac de la Plaine, 1, Rue Brindejonc des Moulinais
BP 5804, 31505 Toulouse Cedex, France
Phone : (33) 5 61 36 03 03 Fax : (33) 5 61 36 03 00
URL : <http://www.icom-france.com>

Asia Icom Inc.

6F No. 68, Sec. 1 Cheng-Teh Road, Taipei, Taiwan, R.O.C.
Phone : (02) 2559 1899 Fax : (02) 2559 1874
URL : <http://www.asia-icom.com>

Count on us!

Icom Inc.

1-1-32, Kamiminami, Hirano-ku, Osaka 547-0003, Japan

S-13911HZ-C1
© 2003 Icom Inc.