



-EVE Power CO., Ltd. Confidential Proprietary-

Model 型号	LF304	Specification No. 规格书编号	PBR1-LF304-D06-01	Version 版本	E
-------------	-------	----------------------------	-------------------	---------------	---

Product Specification

产品交付规格书

Prismatic LFP Cell
方形磷酸铁锂电池

Model: LF304
型号: LF304

Drafted by 编制	Product Design Checked by 产品设计审核	Quality Checked by 品质审核	Sales Checked by 销售审核	Approved by 批准
赵坦	谭明松	李明	黄良	范丁丁

Customer Recipient 客户接收栏	
Company Name	公司名称:
Approved by	批 准:
Date	日 期:

May., 2023
EVE Power Co., Ltd.
湖北亿纬动力有限公司

Model 型号	LF304	Specification No. 规格书编号	PBRI-LF304-D06-01	Version 版本	E
-------------	-------	----------------------------	-------------------	---------------	---

Customer Requirements 客户要求

Customers need to communicate and reach an agreement with EVE Power Co., Ltd. regarding special needs beyond the product specifications. For example, if special applications and operation conditions are not consistent with the description in this specification, EVE design and manufacture products according to customer's special requirements.

客户输出产品规格书以外的特殊需求信息需与亿纬动力沟通并达成一致。例如客户有一些特别的应用或者操作条件不同于此文件中所描述的，亿纬动力根据客户的特别要求进行产品的设计和生。

No. 序号	Special Requirements 特殊要求	Standards 标准
1		
2		
3		
4		
5		

Customer Code 客户代码: _____ Signature 签字: _____ Date 日期: _____

Model 型号	LF304	Specification No. 规格书编号	PBRI-LF304-D06-01	Version 版本	E
-------------	-------	----------------------------	-------------------	---------------	---

Revision History 变更履历

Version 版本	Date 日期	Contents 更改内容	Checked By 确认人
A	2021.07.12	First issue 新版发行	Meng He 贺萌
B	2022.01.26	1. Make a distinction between standard charge-discharge ratio and continuous charge-discharge ratio; 2. Add the term definition of normal capacity and AC resistance; 3. Add the center distance of cell poles; 4. Increase the cell cycles to 2000 at 45 °C; 5. Complete the cautions of battery in use. 1、区分标准充放电倍率及持续充放电倍率； 2、增加额定容量和交流内阻术语定义； 3、增加极柱中心距尺寸； 4、电芯 45 °C 循环寿命增加至 2000 次； 5、完善电芯在使用时注意事项。	Meng He 贺萌
C	2022.03.10	1. Add the definition of “fresh battery” and supplement the definitions of “cell temperature” and “charging rate”; 2. The initial internal resistance standard in the product performance index is changed to “AC, 1 kHz, 30 % ~ 40 % SOC, Fresh battery”; 3. Revision the safety limit parameters; 4. Revision the charge and discharge parameters; 5. Revision the testing methods of storage; 6. Revision the standard of discharge performance; 7. Add pretreatment before battery test. 1、增加“新鲜电池”术语定义并对电芯测试状态进行完善，补充“电芯温度”及“充电倍率”术语定义； 2、产品性能指标中初始内阻标准改为“AC, 1 kHz, 30 % ~ 40 % SOC, 新鲜电池”； 3、修订安全限制参数； 4、修订充放电参数； 5、修订存储测试方法； 6、修订放电性能标准； 7、增加电池测试前预处理。	Meng He 贺萌

Model 型号	LF304	Specification No. 规格书编号	PBRI-LF304-D06-01	Version 版本	E
D	2022.11.08	1. Add product implementation standards; 2. Add the battery performance parameters; 3. Add batch definition and traceability requirements; 4. Improve transportation and loading and unloading requirements and storage environment and method requirements; 5. Add the confidentiality agreement; 6. Add the rights and obligations of both parties. 1、增加产品执行标准； 2、增加电池性能参数； 3、增加批次定义及追溯性要求； 4、完善运输及装卸要求及储存环境和方法要求； 5、增加保密协议； 6、增加双方的权利和义务。			Tan Zhao 赵坦
E	2023.5.31	Adjust chapter content according to the latest EVE specification template. 按照 EVE 最新规格书模板，调整章节内容。			Tan Zhao 赵坦

Model 型号	LF304	Specification No. 规格书编号	PBRI-LF304-D06-01	Version 版本	E
-------------	-------	----------------------------	-------------------	---------------	---

Contents

目录

Customer Requirements 客户要求.....	i
Revision History 变更履历.....	ii
Term Definitions 术语定义	vi
1 Fundamental Information 基本信息.....	- 1 -
1.1 Scope of Application 适用范围	- 1 -
1.2 Product Type 产品类型	- 1 -
1.3 Product Model 产品名称.....	- 1 -
2 Cell Specification and Parameters 电池规格参数	- 1 -
2.1 Basic Specifications and Parameters 基本规格参数.....	- 1 -
2.2 Electrical Performance Parameters 电性能参数	- 3 -
2.3 Safety Performance Parameters 安全性能参数	- 4 -
2.4 Cell Drawing 电池图纸.....	- 4 -
2.5 Appearance 外观.....	- 4 -
3 Test Conditions and Methods 试验条件及方法	- 4 -
3.1 Environmental Conditions 环境条件	- 4 -
3.2 Measuring Instrument 测量设备	- 5 -
3.3 Test Clamp Preparation and Installation 测试夹具准备和安装.....	- 5 -
3.4 Dimensions 尺寸.....	- 6 -
3.5 Weight 重量.....	- 7 -
3.6 Internal Resistance 内阻	- 7 -
3.7 Pretreatment 预处理	- 7 -
3.8 Standard Charge 标准充电.....	- 8 -
3.9 Standard Discharge 标准放电	- 8 -
3.10 1C Capacity Calibration 1C 容量标定	- 8 -
3.11 Rate Discharge Performance 倍率放电性能.....	- 8 -
3.12 High/Low Temperature Discharge Performance 高/低温放电性能.....	- 9 -
3.13 The Capacity Retention and Recovery 荷电保持与恢复.....	- 10 -
3.14 Storage 存储性能	- 11 -
3.15 Cycle Life 循环寿命.....	- 12 -
3.16 Swelling Force Test 膨胀力测试.....	- 15 -
3.17 Safety Performance 安全性能	- 15 -
4 Cell Application Instructions 电池使用说明.....	- 18 -

Model 型号	LF304	Specification No. 规格书编号	PBRI-LF304-D06-01	Version 版本	E
-------------	-------	----------------------------	-------------------	---------------	---

4.1	Welding Parameters Recommendation 焊接参数建议.....	- 18 -
4.2	Charge and Discharge Parameters 充放电参数.....	- 18 -
4.3	Safety Limits 安全限制.....	- 23 -
4.4	Parameters Recommendation for Module Design 模组设计参数建议.....	- 26 -
4.5	Thermodynamic Parameters 热力学参数.....	- 27 -
5	Precautions 注意事项.....	- 28 -
5.1	Product End-life Management 产品寿命终止管理.....	- 28 -
5.2	Long-term Storage 长期存储.....	- 28 -
5.3	Transportation and Handling Requirements 运输及装卸要求.....	- 29 -
5.4	Operation Precautions 操作说明.....	- 29 -
5.5	Confidentiality Agreement 保密协议.....	- 31 -
5.6	Risk Warning 风险警告.....	- 32 -
5.7.	Disclaimer 免责声明.....	- 32 -
6	Others 其他.....	- 33 -
6.1	Rights and Obligations of EVE EVE 的权利和义务.....	- 33 -
6.2	Rights and Obligations of Customer 客户的权利和义务.....	- 33 -
6.3	Language Conflict Clause 语言冲突条款.....	- 34 -

Model 型号	LF304	Specification No. 规格书编号	PBRI-LF304-D06-01	Version 版本	E
-------------	-------	----------------------------	-------------------	---------------	---

Term Definitions 术语定义

Product: Refers to the LF304 rechargeable lithium-ion cell with prismatic aluminum shell manufactured by EVE Power Co., Ltd. (hereinafter referred to as EVE) in this specification.

产品: 本规格书中的“产品”是指湖北亿纬动力有限公司（以下简称 EVE）生产的 LF304 可充电方形铝壳锂离子电池。

Customer: Refers to the buyer in the product sales contract signed with EVE.

客户: 指与 EVE 签署产品销售合同中的买方。

Environment temperature: The ambient temperature where the cell is located.

环境温度: 电池所处的周围环境温度。

Cell temperature: The temperature measured by temperature sensor installed at the center of cell surface. The selection of temperature sensor and measuring line shall be jointly agreed by EVE and the customer.

电池温度: 由接入电池表面中心的温度传感器测量的电池表面的温度，温度传感器和测量线路的选择由 EVE 和客户共同商定。

Fresh cell: Refers to cell within 7 days after production.

新鲜电池: 指电池自产品生产完成日期算起 7 天以内的状态。

Charging Rate: The ratio of the charging current to the capacity which measured by the battery management system. For example, if the cell capacity is 304 Ah and the charging current is 152 A, the charging rate is 0.5C. If the cell capacity drops to 260 Ah and the charging current is 130 A, the charging rate is 0.5C.

充电倍率: 充电电流与电池管理系统监测的电池的容量值的比率。例如：电池容量为 304 Ah，充电电流为 152 A 时，则充电倍率为 0.5C；当电池容量跌落为 260 Ah，充电电流为 130 A 时，则充电倍率为 0.5C。

State of charge: Under unloaded conditions, the ratio of the cell capacity state to the nominal capacity measured in ampere-hour or watt- hour. The abbreviation is expressed by SOC. For example, if the capacity at 304 Ah considered as 100% SOC, the capacity at 0 Ah, considered as 0% SOC.

荷电状态: 在无负载的情况下，以安培小时或者以瓦特小时为单位计量的电池容量状态与标称容量的比值，缩写用 SOC 表示。例如：若将容量为 304 Ah 的状态视为 100% SOC，若容量为 0 Ah 时，SOC 为 0%。

State of health: The ratio of actual cell capacity to nominal capacity, The abbreviation is expressed by SOH. For example, if the cell capacity at 304 Ah considered as 100% SOH, the cell capacity decays to 243.2 Ah, considered as 80% SOH.

健康状态: 电池实际容量与标称容量的比值，缩写用 SOH 表示。例如：电池容量 304Ah 为 100% SOH，容量衰减为 243.2 Ah 时，SOH 为 80%。

Cycle: The cell is charged and discharged once as a cycle according to the specified charging and discharging standards. The cell shall be charged and discharged once according to the specified charging and discharging standards as a cycle. The cycle includes short-term normal charging or a combination of regenerative charging and

Model 型号	LF304	Specification No. 规格书编号	PBRI-LF304-D06-01	Version 版本	E
-------------	-------	----------------------------	-------------------	---------------	---

discharging processes. In the charging process, sometimes there is only normal charging and no regenerative charging. The discharge can be formed by combining some partial discharges.

循环: 电池按规定的充放标准充放一次为一个循环。循环包括短时的正常充电或者再生充电和放电过程的组合，在充电过程中有时只有正常充电而无再生充电的情况。放电可以由一些部分放电组合在一起形成。

Standard charge: The charging mode described in 3.8 of this specification.

标准充电: 本规格书第 3.8 条所述的充电模式。

Standard discharge: The discharging mode described in 3.9 of this specification.

标准放电: 本规格书第 3.9 条所述的放电模式。

Open circuit voltage: The voltage of the cell measured when unloaded or circuit is disconnected. The abbreviation is expressed by OCV.

开路电压: 没有接入任何负载和电路时测得的电池的电压，缩写用 OCV 表示。

AC resistance: Apply 1kHz sine wave current between the positive and negative poles of the cell, and the internal resistance obtained, which abbreviated as ACR. The test method is as described in section 3.6 of this specification.

交流内阻: 给电池正负极注入 1kHz 的正弦波电流，测试所得到的内阻值，缩写用 ACR 表示，测试方法如本规格书第 3.6 条所述。

DC resistance: The ratio of the voltage change to the corresponding current change under working conditions, and the abbreviation is DCR. The test method is as described in section 3.6 of this specification.

直流内阻: 工作条件下电池的电压变化与相应的电流变化之比，缩写用 DCR 表示，测试方法如本规格书第 3.6 条所述。

Module: The intermediate product between single cell and pack, which is formed by lithium-ion cells in series and parallel after installing cell monitors and management devices.

模组: 锂离子电池经串并联方式组合，加装单体电池监控与管理装置后形成的电池与 pack 的中间产品。

Pulse current: The currents that appear periodically are called pulse currents. The pulse currents appear either in the same direction or in alternating positive and negative directions.

脉冲电流: 以周期重复出现的电流为脉冲电流，脉冲电流或是以同一方向出现，或是以正、负交替变换方向出现。

Compression force: When the module is assembled, the cell can withstand the force perpendicular to the cell stacking direction.

压缩力: 模组组装时，电池可承受压缩力的安全边界。

Swelling force: The inherent characteristics such as the rebound of the electrode thickness may lead to cell expansion during use which generates force on the clamp.

膨胀力: 在使用过程中，因极片厚度反弹等固有特性导致电池膨胀，而对约束夹具产生的作用力。

Model 型号	LF304	Specification No. 规格书编号	PBRI-LF304-D06-01	Version 版本	E
-------------	-------	----------------------------	-------------------	---------------	---

Units of measurement: Refer to following table

测量单位：见下表

Table 1 Units of measurement

表 1 测量单位

No. 序号	Units 单位	Abbreviation 简写	Type of units 单位类型
1	Volt 伏特	V	Voltage 电压单位
2	Ampere 安培	A	Current 电流单位
3	Ampere-Hour 安培-小时	Ah	Capacity 容量单位
4	Watt-Hour 瓦特-小时	Wh	Energy 能量单位
5	Ohm 欧姆	Ω	Resistance 电阻单位
6	Milliohm 毫欧姆	m Ω	Resistance 电阻单位
7	Degree Celsius 摄氏度	$^{\circ}\text{C}$	Temperature 温度单位
8	Millimeter 毫米	mm	Length 长度单位
9	Second 秒	s	Time 时间单位
10	Hertz 赫兹	Hz	Frequency 频率单位
11	Newton 牛顿	N	Force 力单位
12	Kilogram-Force 千克力	kgf	Force 力单位

Model 型号	LF304	Specification No. 规格书编号	PBRI-LF304-D06-01	Version 版本	E
-------------	-------	----------------------------	-------------------	---------------	---

1 Fundamental Information 基本信息

1.1 Scope of Application 适用范围

This document describes the specification of the LF304 lithium-ion cell manufactured by EVE Power Co., Ltd.
本产品规格书适用于 EVE 生产的 LF304 锂离子电池。

1.2 Product Type 产品类型

Prismatic lithium-ion cell with aluminum shell. 方形铝壳锂离子电池。

1.3 Product Model 产品名称

LF304

2 Cell Specification and Parameters 电池规格参数

2.1 Basic Specifications and Parameters 基本规格参数

Table 2 Basic specifications and parameters

表 2 基本规格参数

Items 项目	Specification 规格	Notes 备注
Nominal Capacity 标称容量	304.0 Ah	0.5C / 0.5C, 25°C ± 2°C, 2.5 V ~ 3.65 V, Fresh cell 新鲜电池
Nominal Energy 标称能量	972.8 Wh	
Nominal Voltage 标称电压	3.2 V	0.5C discharge, 25°C ± 2°C, 2.5 V ~ 3.65 V 0.5C 放电, 25°C ± 2°C, 2.5 V ~ 3.65 V
End-off-charge Voltage 充电终止电压 (U_{max})	3.65 V	/
End-off-discharge Voltage 放电终止电压 (U_{min})	2.5 V ($T > 0^{\circ}\text{C}$) 2.0 V ($T \leq 0^{\circ}\text{C}$)	/
Standard Charging Current 标准充电电流	152 A	0.5C
Maximum Instantaneous Charging Current 最大瞬间充电电流	2C	30 s, ≤ 80% SOC, 25°C ± 2°C
Standard Discharging Current 标准放电电流	152 A	0.5C

Model 型号	LF304	Specification No. 规格书编号	PBRI-LF304-D06-01	Version 版本	E
Maximum Instantaneous Discharging Current 最大瞬间放电电流		3C	30 s, $\geq 30\%$ SOC, $25^{\circ}\text{C} \pm 2^{\circ}\text{C}$		
Initial IR 初始内阻		$0.16 \text{ m}\Omega \pm 0.05 \text{ m}\Omega$	AC, 1 kHz, 19% ~ 40% SOC, Fresh cell 新鲜电池		
Direct Current Resistance (DCR) 直流内阻		$\leq 1.2 \text{ m}\Omega$	25°C, 50% SOC, 1C, 10 s, Fresh cell 新鲜电池		
Weight 重量		5450 g \pm 164 g	/		
Dimension 尺寸 (With Insulation Film 含蓝膜)	Terminal Height 高度 1 (H1)	207.20 mm \pm 0.50 mm	With Terminal 含极柱		
	Can-top Height 高度 2 (H2)	204.40 mm \pm 0.50 mm	Without Terminal 不包含极柱		
	Length 宽度 (L)	173.70 mm \pm 0.50 mm	/		
	Thickness 厚度 (T)	71.70 mm \pm 0.80 mm	(300 kgf \pm 20 kgf compression force, Delivery SOC) (300 kgf \pm 20 kgf 压缩力, 出货 SOC)		
	Center Distance between Poles 极柱中心距 (D)	123.00 mm \pm 0.30 mm	/		
Operation Temperature 工作温度	Charge Temperature 充电温度	$-10^{\circ}\text{C} \sim 65^{\circ}\text{C}$	/		
	Discharge Temperature 放电温度	$-35^{\circ}\text{C} \sim 65^{\circ}\text{C}$	/		
Storage Temperature 存储温度	3 months 3 个月内	$0^{\circ}\text{C} \sim 35^{\circ}\text{C}$	Delivery SOC 出货 SOC 状态		
	1 month 1 个月内	$-20^{\circ}\text{C} \sim 45^{\circ}\text{C}$			
Swelling force at EOL EOL 膨胀力		$\leq 30000 \text{ N}$	80% SOH		

Model 型号	LF304	Specification No. 规格书编号	PBRI-LF304-D06-01	Version 版本	E
-------------	-------	----------------------------	-------------------	---------------	---

2.2 Electrical Performance Parameters 电性能参数

Table 3 Electrical performance parameters

表 3 电性能参数表

Items 项目	Specifications 规格			Testing Methods 测试方法
Rate Discharge Performance 倍率放电性能	Items 项目 Rate 倍率	Discharging Capacity 放电容量	Capacity Retention 容量保持率	/
	1C	C ₀	100%	3.10
	0.5C	C ₁	C ₁ /C ₀ ≥ 98%	3.11
High/Low Temperature Discharge Performance 高/低温放电性能	Items 项目 Temp.温度	Discharging Capacity 放电容量	Capacity Retention 容量保持率	3.12
	-20°C	C ₂	C ₂ /C ₀ ≥ 75%	
	0°C	C ₃	C ₃ /C ₀ ≥ 85%	
	25°C	C ₀	100%	
	45°C	C ₄	C ₄ /C ₀ ≥ 97%	
	55°C	C ₅	C ₅ /C ₀ ≥ 97%	
The Capacity Retention and Recovery 荷电保持与恢复 (100%SOC)	Items 项目 Temp.温度	Capacity Retention 容量保持率	Capacity Recovery 容量恢复率	3.13
	25°C & 28days	≥ 96%*C ₀	≥ 97%*C ₀	
	45°C & 28days	≥ 93%*C ₀	≥ 95%*C ₀	
	55°C & 7days	≥ 95%*C ₀	≥ 96%*C ₀	
Storage 存储性能 (50%SOC)	Items 项目 Temp.温度	Capacity Recovery 容量恢复率		3.14
	25°C & 28days	≥ 98%*C ₀		
	45°C & 28days	≥ 97%*C ₀		
Cycle Life 循环寿命	25°C Cycle 25°C循环	4000 cycles, 80% SOH, 25°C		3.15
	45°C Cycle 45°C循环	2000 cycles, 80% SOH, 45°C		

Model 型号	LF304	Specification No. 规格书编号	PBRI-LF304-D06-01	Version 版本	E
-------------	-------	----------------------------	-------------------	---------------	---

2.3 Safety Performance Parameters 安全性能参数

Table 4 Safety performance parameters

表 4 安全性能参数

Items 项目	Specifications 规格	Testing Methods 测试方法
Overdischarge 过放电	No fire, No explosion 不起火、不爆炸	3.17.1
Overcharge 过充电	No fire, No explosion 不起火、不爆炸	3.17.2
External Short-circuit 外部短路	No fire, No explosion 不起火、不爆炸	3.17.3
Heating 加热	No fire, No explosion 不起火、不爆炸	3.17.4
Temperature Cycling 温度循环	No fire, No explosion 不起火、不爆炸	3.17.5
Extrusion Test 挤压	No fire, No explosion 不起火、不爆炸	3.17.6

2.4 Cell Drawing 电池图纸

See Appendix 见附录。

2.5 Appearance 外观

The cell shall not have any defects that may affect their commercial values, including obvious scratches, cracks, rust stains, discoloration, or electrolyte leakage.

电池应无明显擦伤、裂痕、锈渍、变色或电解液泄漏这类对电池商用价值有影响的缺陷。

3 Test Conditions and Methods 试验条件及方法

3.1 Environmental Conditions 环境条件

Unless otherwise specified, the test should be carried out in an environmental temperature of $25\text{ }^{\circ}\text{C} \pm 2\text{ }^{\circ}\text{C}$, relative humidity of 10% ~ 90%, and atmospheric pressure of 86 kPa to 106 kPa. The room temperature mentioned in this specification refers to $25\text{ }^{\circ}\text{C} \pm 2\text{ }^{\circ}\text{C}$.

除另有规定外，试验应在温度为 $25\text{ }^{\circ}\text{C} \pm 2\text{ }^{\circ}\text{C}$ ，相对湿度 10% ~ 90%，大气压力为 86 kPa ~ 106 kPa 的环境中进行。本规格书所提到的室温，是指 $25\text{ }^{\circ}\text{C} \pm 2\text{ }^{\circ}\text{C}$ 。

Model 型号	LF304	Specification No. 规格书编号	PBRI-LF304-D06-01	Version 版本	E
-------------	-------	----------------------------	-------------------	---------------	---

3.2 Measuring Instrument 测量设备

The accuracy of measuring device should meet the following requirements:

试验装置应符合下列要求:

- A. Voltage measuring device 电压测量装置: $\pm 0.05\%$ FS;
- B. Current measuring device 电流测量装置: $\pm 0.05\%$ FS;
- C. Temperature measuring device 温度测量装置: $\pm 1^\circ\text{C}$;
- D. Dimension measuring device 尺寸测量装置: $\pm 0.01\text{ mm}$;
- E. Weight measuring device 重量测量装置: $\pm 0.1\text{ g}$.

Note: During the testing process, voltage, current, ambient temperature, and battery temperature must be recorded.

It is recommended to collect the cell temperature at the terminal and the center of large surface (or side).

备注: 测试过程中, 均需记录电压、电流、环境温度和电池温度, 电池温度采集点建议布置在极柱和大面(或侧面)中心处。

3.3 Test Clamp Preparation and Installation 测试夹具准备和安装

3.3.1 Ordinary Steel Clamp 普通钢夹具

The single cell shall be clamped with steel splints (thickness: 8 mm). The splints need to cover the large surfaces of the cell and be fixed with 6 M6 bolts. All sides of the splints need to be covered with insulating film. Clamp as shown below:

单体电池需采用钢夹板(厚度: 8 mm)固定, 夹板需要覆盖住电池大面, 夹板之间采用6个M6螺栓固定, 夹板各个面需要有绝缘膜, 夹具工装如下图所示:

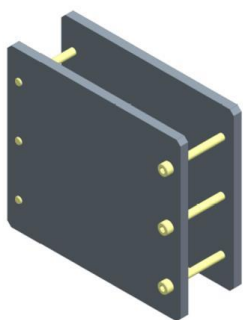

Fig. 1 Diagram of cell clamp
图 1 夹具示意图

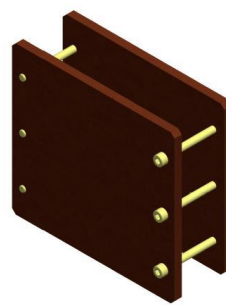

Fig. 2 Diagram of the clamp covered with insulation film
图 2 电池夹具包绝缘膜图

Place the cell (15% ~ 40%SOC) which is covered with blue film (material: PET, thickness: 0.1 mm) and top film (material: PC, thickness: 0.3mm) in the middle of the splint, fix the steel fixture with 6 M6 bolts to ensure that the initial preload of the battery on the fixture is $300\text{ kgf} \pm 20\text{ kgf}$. Then use a micrometer to measure the thickness of the cell (at upper, middle and lower) with splints, and the thickness tolerance shall be controlled within 0.3 mm.

Model 型号	LF304	Specification No. 规格书编号	PBRI-LF304-D06-01	Version 版本	E
-------------	-------	----------------------------	-------------------	---------------	---

将包覆有蓝膜（材质：PET，厚度 0.1 mm）和顶底部贴片（材质：PC，厚度 0.3 mm）的电池（15% ~ 40%SOC）准备好后，置于夹具中间，使用 6 个 M6 螺栓固定钢夹具保证电池受夹具初始预紧力为 300 kgf ± 20 kgf，需采用千分尺测量带夹板电池的厚度（上、中、下），厚度差异需控制小于等于 0.3 mm。

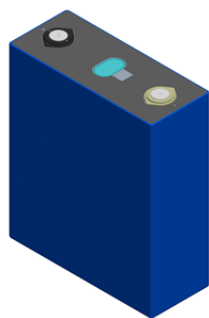

Fig. 3 Diagram of cell filming
图 3 电池包膜示意图

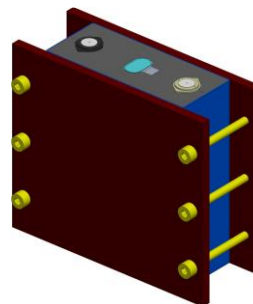

Fig. 4 Diagram of cell with clamp
图 4 电池上夹具图

3.3.2 Swelling force clamp 膨胀力夹具

Place the cell (15% ~ 40%SOC) which is covered with blue film (material: PET, thickness: 0.1 mm) and top film (material: PC, thickness: 0.3 mm) in the middle of the splint, adjusting Swelling force clamp pretensioning device and the initial compression force is (300 kgf ± 20 kgf). Then use a micrometer to measure the thickness of the cell (at upper, middle and lower) with splints, and the thickness tolerance shall be controlled within 0.3 mm.

将包覆有蓝膜（材质：PET，厚度 0.1 mm）和顶底部贴片（材质：PC，厚度 0.3 mm）的电池（15% ~ 40%SOC）准备好后，置于膨胀力夹具中间，调节膨胀力夹具预紧装置，使传感显示装置压缩力为 300 kgf ± 20 kgf。上夹板后，需采用千分尺测量带夹板电池的厚度（上、中、下），厚度差异需控制小于等于 0.3 mm。

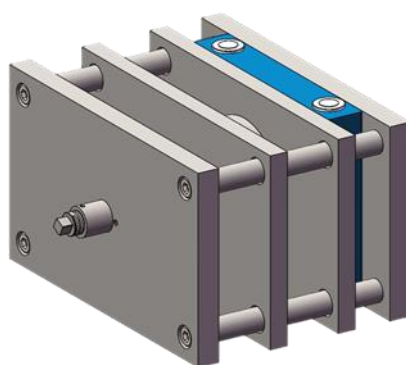

Fig. 5 Diagram of cell with swelling force clamp
图 5 电池上膨胀力夹具图

3.4 Dimensions 尺寸

Test instrument: Automatic wrapping machine;

试验设备：自动包膜机；

Model 型号	LF304	Specification No. 规格书编号	PBRI-LF304-D06-01	Version 版本	E
-------------	-------	----------------------------	-------------------	---------------	---

Test method: Use the wrapping machine to measure the length, width and height of the cell. And apply a 300 kgf \pm 20 kgf force on it.

试验方法：使用自动包膜机测试电池长度、宽度和高度，施加 300 kgf \pm 20 kgf 的压力。

The thickness of the cell will increase as the SOC increases as well as with the using time. The thickness here indicates the thickness of the cell at the time of delivery.

电池厚度随着 SOC 增加会有所增加，随着使用时间增加会有所增加，此处厚度指出货时电池的厚度。

3.5 Weight 重量

Test instrument: electronic scale;

试验设备：电子秤；

Test method: measure the weight of the cell by electronic scale.

试验方法：使用电子秤测量电池的重量。

3.6 Internal Resistance 内阻

a. ACR: test the cell at delivery SOC with 1kHz sine wave current at room temperature.

a. 交流内阻（ACR）：在室温条件下，出货 SOC 电池采用 1 kHz 正弦波电流进行测试。

b. DCR: Capacity calibration is carried out according to 3.10. Charge cell to 3.65 V with constant current of 1C, and then charge at constant voltage of 3.65 V until the current decreases to 0.05C. Rest for 30 min, and discharge with constant current of 0.5C for 60 min afterwards (adjust the SOC to 50%). Then rest for 1 h, and record the voltage V_1 at the end of the period. Put a 10 s discharge pulse current of 1C and record the voltage V_2 at the end of the pulse, and calculate the DCR., $DCR = (V_1 - V_2) \times 1000 / 304.0$ (m Ω).

b. 直流内阻（DCR）：对电池按照 3.10 的方法进行容量标定，电池以 1C 的电流恒流充电至 3.65 V 后，转恒压充电至充电电流为 0.05C 截止，搁置 30 min，然后以 0.5C 恒流放电 60min（调整 SOC 为 50%），搁置 1 h，记录搁置末期电压 V_1 ，用 1C 恒流放电 10 s，记录放电末期电压 V_2 ，计算 DCR， $DCR = (V_1 - V_2) \times 1000 / 304.0$ (m Ω)。

3.7 Pretreatment 预处理

Before the formal test, pretreat the cell to ensure it is activated and stable. The steps are as follows:

正式测试开始前，电池需要先进行预处理循环，以确保试验对象的性能处于激活和稳定的状态。其步骤如下：

a. Charge the cell according to the standard charging mode;

a. 电池按照标准充电模式充电；

b. Discharge the cell according to the standard discharging mode;

b. 电池按照标准放电模式放电；

c. Repeat a~b no more than 5 times;

c. 重复 a~b 不超过 5 次；

Model 型号	LF304	Specification No. 规格书编号	PBRI-LF304-D06-01	Version 版本	E
-------------	-------	----------------------------	-------------------	---------------	---

If the discharge capacity of the cell changes no more than 3% of the nominal capacity for two consecutive times, it is considered that the cell has completed the pretreatment, and the pretreatment cycle can be terminated.

如果电池连续两次的放电容量变化不高于标称容量的 3%，则认为电池完成了预处理，预处理循环可以中止。

3.8 Standard Charge 标准充电

Charge cell to 3.65 V with constant current of 0.5C at ambient temperature of $25^{\circ}\text{C} \pm 2^{\circ}\text{C}$, then charge at constant voltage of 3.65 V until the current decreases to 0.05C, and rest for 30 min.

在环境温度 $25^{\circ}\text{C} \pm 2^{\circ}\text{C}$ 的条件下，对电池以 0.5C 电流恒流充电至 3.65 V，然后在 3.65 V 下转恒压充电，直至充电电流至 0.05C，搁置 30 min。

3.9 Standard Discharge 标准放电

Discharge the cell to 2.5 V with constant current of 0.5C at ambient temperature of $25^{\circ}\text{C} \pm 2^{\circ}\text{C}$, and rest for 30 min.

在环境温度 $25^{\circ}\text{C} \pm 2^{\circ}\text{C}$ 的条件下，电池以 0.5C 电流恒流放电，放电至电压达到 2.5 V 截止，搁置 30 min。

3.10 1C Capacity Calibration 1C 容量标定

Charge the cell to 3.65 V with constant current of 1C at ambient temperature of $25^{\circ}\text{C} \pm 2^{\circ}\text{C}$ (constant temperature without air convection). Then charge at constant voltage of 3.65 V until the current decreases to 0.05C, rest for 30 min. After that, discharge the cell to 2.5 V with constant current of 1C, lastly rest for 30 min. Repeat the above steps 5 times, and the average discharge capacity of the last 3 times is the 1C discharge capacity, which is recorded as C_0 .

在环境温度 $25^{\circ}\text{C} \pm 2^{\circ}\text{C}$ 的条件下，电池以 1C 电流恒流充电至 3.65 V 后，转恒压充电至充电电流为 0.05C 截止，搁置 30 min，然后 1C 放电至 2.5 V，搁置 30 min。按照以上充放电方式重复 5 次，最后 3 次的平均放电容量即为 1C 放电容量，记录放电容量为标定容量 C_0 。

3.11 Rate Discharge Performance 倍率放电性能

Capacity calibration is carried out according to 3.10. Charge the cell to 3.65 V with constant current of 1C at ambient temperature of $25^{\circ}\text{C} \pm 2^{\circ}\text{C}$, and then charge at constant voltage of 3.65 V until the current decreases to 0.05C. After that, rest for 30 min, and discharge it to 2.5 V with constant current of 0.5C. Discharge capacity is recorded as C_1 , and $C_1 / C_0 \times 100\%$ is the capacity retention rate at 0.5C.

对电池按照 3.10 的方法进行容量标定。在环境温度 $25^{\circ}\text{C} \pm 2^{\circ}\text{C}$ 的条件下，电池以 1C 电流恒流充电至 3.65 V 后，转恒压充电至充电电流为 0.05C 截止。搁置 30min，用 0.5C 电流恒流放电至 2.5 V，记录放电容量 C_1 ， $C_1 / C_0 \times 100\%$ 即为 0.5C 容量保持率。

Model 型号	LF304	Specification No. 规格书编号	PBRI-LF304-D06-01	Version 版本	E
-------------	-------	----------------------------	-------------------	---------------	---

3.12 High/Low Temperature Discharge Performance 高/低温放电性能

3.12.1 -20°C Capacity Retention Rate -20°C容量保持率

Capacity calibration is carried out according to 3.10. Charge the cell to 3.65 V with constant current of 1C at ambient temperature of $25^{\circ}\text{C} \pm 2^{\circ}\text{C}$, and then charge at constant voltage of 3.65 V until the current decreases to 0.05C. After that, rest the cell at $-20^{\circ}\text{C} \pm 2^{\circ}\text{C}$ for 24 h, and discharge it to 2.0 V with constant current of 1C under the environment of $-20^{\circ}\text{C} \pm 2^{\circ}\text{C}$. Discharge capacity is recorded as C_2 , and $C_2 / C_0 \times 100\%$ is the capacity retention rate at -20°C .

对电池按照 3.10 的方法进行容量标定。在环境温度 $25^{\circ}\text{C} \pm 2^{\circ}\text{C}$ 的条件下，电池以 1C 电流恒流充电至 3.65 V 后，转恒压充电至充电电流为 0.05C 截止。然后在 $-20^{\circ}\text{C} \pm 2^{\circ}\text{C}$ 的环境下搁置 24 h，在 $-20^{\circ}\text{C} \pm 2^{\circ}\text{C}$ 的环境下用 1C 电流恒流放电至 2.0 V，记录放电容量 C_2 ， $C_2 / C_0 \times 100\%$ 即为 -20°C 容量保持率。

3.12.2 0°C Capacity Retention Rate 0°C容量保持率

Capacity calibration is carried out according to 3.10. Charge the cell to 3.65 V with constant current of 1C at ambient temperature of $25^{\circ}\text{C} \pm 2^{\circ}\text{C}$, and then charge at constant voltage of 3.65 V until the current decreases to 0.05C. After that, rest the cell at $0^{\circ}\text{C} \pm 2^{\circ}\text{C}$ for 24 h, and discharge it to 2.0 V with constant current of 1C under the environment of $0^{\circ}\text{C} \pm 2^{\circ}\text{C}$. Discharge capacity is recorded as C_3 , and $C_3 / C_0 \times 100\%$ is the capacity retention rate at 0°C .

对电池按照 3.10 的方法进行容量标定。在环境温度 $25^{\circ}\text{C} \pm 2^{\circ}\text{C}$ 的条件下，电池以 1C 电流恒流充电至 3.65 V 后，转恒压充电至充电电流为 0.05C 截止。然后在 $0^{\circ}\text{C} \pm 2^{\circ}\text{C}$ 的环境下搁置 24 h，在 $0^{\circ}\text{C} \pm 2^{\circ}\text{C}$ 的环境下用 1C 电流恒流放电至 2.0 V，记录放电容量 C_3 ， $C_3 / C_0 \times 100\%$ 即为 0°C 容量保持率。

3.12.3 45°C Capacity Retention Rate 45°C容量保持率

Capacity calibration is carried out according to 3.10. Charge the cell to 3.65 V with constant current of 1C at ambient temperature of $25^{\circ}\text{C} \pm 2^{\circ}\text{C}$, and then charge at constant voltage of 3.65 V until the current decreases to 0.05C. After that, rest the cell at $45^{\circ}\text{C} \pm 2^{\circ}\text{C}$ for 5 h, and discharge it to 2.5 V with constant current of 1C under the environment of $45^{\circ}\text{C} \pm 2^{\circ}\text{C}$. Discharge capacity is recorded as C_4 , and $C_4 / C_0 \times 100\%$ is the capacity retention rate at 45°C .

对电池按照 3.10 的方法进行容量标定。在环境温度 $25^{\circ}\text{C} \pm 2^{\circ}\text{C}$ 的条件下，电池以 1C 电流恒流充电至 3.65 V 后，转恒压充电至充电电流为 0.05C 截止。然后在 $45^{\circ}\text{C} \pm 2^{\circ}\text{C}$ 的环境下搁置 5 h，在 $45^{\circ}\text{C} \pm 2^{\circ}\text{C}$ 的环境下用 1C 电流恒流放电至 2.5 V，记录放电容量 C_4 ， $C_4 / C_0 \times 100\%$ 即为 45°C 容量保持率。

3.12.4 55°C Capacity Retention Rate 55°C容量保持率

Capacity calibration is carried out according to 3.10. Charge the cell to 3.65 V with constant current of 1C at ambient temperature of $25^{\circ}\text{C} \pm 2^{\circ}\text{C}$, and then charge at constant voltage of 3.65 V until the current decreases to 0.05C. After that, rest the cell at $55^{\circ}\text{C} \pm 2^{\circ}\text{C}$ for 5 h, and discharge it to 2.5 V with constant current of 1C under the environment

Model 型号	LF304	Specification No. 规格书编号	PBRI-LF304-D06-01	Version 版本	E
-------------	-------	----------------------------	-------------------	---------------	---

of $55^{\circ}\text{C} \pm 2^{\circ}\text{C}$. Discharge capacity is recorded as C_5 , and $C_5 / C_0 \times 100\%$ is the capacity retention rate at 55°C .

对电池按照 3.10 的方法进行容量标定。在环境温度 $25^{\circ}\text{C} \pm 2^{\circ}\text{C}$ 的条件下，电池以 1C 电流恒流充电至 3.65 V 后，转恒压充电至充电电流为 0.05C 截止。然后在 $55^{\circ}\text{C} \pm 2^{\circ}\text{C}$ 的环境下搁置 5 h，在 $55^{\circ}\text{C} \pm 2^{\circ}\text{C}$ 的环境下用 1C 电流恒流放电至 2.5 V，记录放电容量 C_5 ， $C_5 / C_0 \times 100\%$ 即为 55°C 容量保持率。

3.13 The Capacity Retention and Recovery 荷电保持与恢复

3.13.1 25°C Capacity Retention and Recovery 25°C 荷电保持与恢复

Capacity calibration is carried out according 3.10. Charge the cell to 3.65 V with constant current of 1C, then switching to constant voltage charging at 3.65 V until the charging current reaches 0.05C, and rest for 28 days afterwards at ambient temperature of $25^{\circ}\text{C} \pm 2^{\circ}\text{C}$. Discharge the cell to 2.5 V with constant current of 1C at ambient temperature of $25^{\circ}\text{C} \pm 2^{\circ}\text{C}$ (record the discharge capacity as C_6), and rest for 30 min. Then charge it to 3.65 V with constant current of 1C, switching to constant voltage charging when the cut-off current is 0.05C, and rest for 30 min. Then discharge to 2.5 V with constant current of 1C (record the discharge capacity C_7). Capacity retention rate= $C_6 / C_0 \times 100\%$, capacity recovery rate= $C_7 / C_0 \times 100\%$.

对电池按照 3.10 的方法进行容量标定。电池以 1C 电流恒流充电至 3.65 V，在 3.65 V 下转恒压充电，直至充电电流为 0.05C，然后在环境温度 $25^{\circ}\text{C} \pm 2^{\circ}\text{C}$ 的条件下搁置 28 天，之后在环境温度 $25^{\circ}\text{C} \pm 2^{\circ}\text{C}$ 的条件下按照 1C 放电至 2.5 V（记录放电容量 C_6 ），搁置 30 min，再按照 1C 电流恒流充电至 3.65 V，在 3.65 V 下转恒压充电，直至充电电流为 0.05C，搁置 30 min，用 1C 放电至 2.5 V（记录放电容量 C_7 ）。容量保持率= $C_6 / C_0 \times 100\%$ ，容量恢复率= $C_7 / C_0 \times 100\%$ 。

3.13.2 45°C Capacity Retention and Recovery 45°C 荷电保持与恢复

Capacity calibration is carried out according 3.10. Charge the cell to 3.65 V with constant current of 1C, then switching to constant voltage charging at 3.65 V until the charging current decreases to 0.05C, and rest for 28 days afterwards at ambient temperature of $45^{\circ}\text{C} \pm 2^{\circ}\text{C}$. Rest for 5 h at ambient temperature of $25^{\circ}\text{C} \pm 2^{\circ}\text{C}$, and then discharge the cell to 2.5 V with constant current of 1C (record the discharge capacity C_8). After rest for 30 min, charge it to 3.65 V with constant current of 1C, and switch to constant voltage charging when the cut-off current is 0.05C. Rest for 30 min, and then discharge to 2.5 V with constant current of 1C (record the discharge capacity C_9). Capacity retention rate= $C_8 / C_0 \times 100\%$, capacity recovery rate= $C_9 / C_0 \times 100\%$.

对电池按照 3.10 的方法进行容量标定。电池以 1C 电流恒流充电至 3.65 V，在 3.65 V 下转恒压充电，直至充电电流为 0.05C，然后在环境温度 $45^{\circ}\text{C} \pm 2^{\circ}\text{C}$ 的条件下搁置 28 天，之后在环境温度 $25^{\circ}\text{C} \pm 2^{\circ}\text{C}$ 的条件下搁置 5 h，随后按照 1C 放电至 2.5 V（记录放电容量 C_8 ），搁置 30 min，再按照 1C 电流恒流充电至 3.65 V，在 3.65 V 下转恒压充电，直至充电电流为 0.05C，搁置 30 min，用 1C 放电至 2.5 V（记录放电容量 C_9 ）。容量保持率= $C_8 / C_0 \times 100\%$ ，容量恢复率= $C_9 / C_0 \times 100\%$ 。

Model 型号	LF304	Specification No. 规格书编号	PBRI-LF304-D06-01	Version 版本	E
-------------	-------	----------------------------	-------------------	---------------	---

3.13.3 55°C Capacity Retention and Recovery 55°C荷电保持与恢复

Capacity calibration is carried out according 3.10. Charge the cell to 3.65 V with constant current of 1C, then switching to constant voltage charging at 3.65 V until the charging current decreases to 0.05C, and rest for 7 days at ambient temperature of 55°C ± 2°C. Rest for 5 h at ambient temperature of 25°C ± 2°C, and discharge the cell to 2.5 V with constant current of 1C (record the discharge capacity C₁₀). After rest for 30 min, then charge it to 3.65 V with constant current of 1C, and switch to constant voltage charging when the cut-off current is 0.05C. Rest for 30 min, and then discharge to 2.5 V with constant current of 1C (record the discharge capacity C₁₁). Capacity retention rate= $C_{10}/C_0 \times 100\%$, capacity recovery rate= $C_{11}/C_0 \times 100\%$.

对电池按照 3.10 的方法进行容量标定。电池以 1C 电流恒流充电至 3.65 V，在 3.65 V 下转恒压充电，直至充电电流为 0.05C，然后在环境温度 55°C ± 2°C 的条件下搁置 7 天，之后在环境温度 25°C ± 2°C 的条件下搁置 5 h，随后按照 1C 放电至 2.5 V（记录放电容量 C₁₀），搁置 30 min，再按照 1C 电流恒流充电至 3.65 V，在 3.65 V 下转恒压充电，直至充电电流为 0.05C，搁置 30 min，用 1C 放电至 2.5 V（记录放电容量 C₁₁）。容量保持率= $C_{10}/C_0 \times 100\%$ ，容量恢复率= $C_{11}/C_0 \times 100\%$ 。

3.14 Storage 存储性能

3.14.1 25°C Storage 25°C存储

Capacity calibration is carried out according 3.10. Charge the cell to 3.65 V with constant current of 1C, switching to constant voltage charging until the cut-off current is 0.05C, and rest for 30 min. Then discharge cell to 2.5 V with constant current of 1C. Rest for 28 days at ambient temperature of 25°C ± 2°C. Discharge the cell to 2.5 V with constant current of 1C at ambient temperature of 25°C ± 2°C, and rest for 30 min. Then charge it to 3.65 V with constant current of 1C, switching to constant voltage charging until the cut-off current is 0.05C, and rest for 30 min. Then discharge to 2.5V with constant current of 1C (record the discharge capacity C₁₂). Capacity recovery rate= $C_{12}/C_0 \times 100\%$.

对电池按照 3.10 的方法进行容量标定。电池 1C 恒流充电至 3.65 V，在 3.65 V 下转恒压充电，直至充电电流为 0.05C，搁置 30 min，用 1C 放电 30 min，然后在环境温度 25°C ± 2°C 的条件下搁置 28 天，之后在环境温度 25°C ± 2°C 的条件下按照 1C 放电至 2.5 V，搁置 30 min，再按照 1C 电流恒流充电至 3.65 V，在 3.65 V 下转恒压充电，直至充电电流为 0.05C，搁置 30 min，用 1C 放电至 2.5 V（记录放电容量 C₁₂）。容量恢复率= $C_{12}/C_0 \times 100\%$ 。

3.14.2 45°C Storage 45°C存储

Capacity calibration is carried out according 3.10. Charge the cell to 3.65 V with constant current of 1C, switching to constant voltage charging until the cut-off current is 0.05C, and rest for 30 min. Then discharge cell to 2.5 V with constant current of 1C. Rest for 28 days at ambient temperature of 45°C ± 2°C. Rest for 5 h at ambient temperature of 25°C ± 2°C, and discharge the cell to 2.5 V with constant current of 1C. Rest for 30 min, charging it to 3.65 V with constant current of 1C, and switch to constant voltage charging until the cut-off current is 0.05C. Rest for 30 min, and

Model 型号	LF304	Specification No. 规格书编号	PBRI-LF304-D06-01	Version 版本	E
-------------	-------	----------------------------	-------------------	---------------	---

then discharge to 2.5 V with constant current of 1C (record the discharge capacity C_{13}). Capacity recovery rate= $C_{13} / C_0 \times 100\%$.

对电池按照 3.10 的方法进行容量标定。电池 1C 恒流充电至 3.65 V，在 3.65 V 下转恒压充电，直至充电电流为 0.05C，搁置 30 min，用 1C 放电 30 min，然后在环境温度 $45^\circ\text{C} \pm 2^\circ\text{C}$ 的条件下搁置 28 天，之后在环境温度 $25^\circ\text{C} \pm 2^\circ\text{C}$ 的条件下搁置 5 h，按照 1C 放电至 2.5 V，搁置 30 min，然后按照 1C 的电流恒流充电至 3.65 V，在 3.65 V 下转恒压充电，直至充电电流为 0.05C，搁置 30 min，用 1C 放电至 2.5 V（记录放电容量 C_{13} ）。容量恢复率= $C_{13} / C_0 \times 100\%$ 。

3.15 Cycle Life 循环寿命

3.15.1 25°C 0.5C / 0.5C Cycle 25°C 0.5C / 0.5C 循环

Before the test, prepare and install the clamp according to 3.3.1.

测试前按照 3.3.1 进行夹具准备和安装。

Initial capacity test before cycling: test the cell capacity according to (3.10). and record the initial capacity as C_0 .

循环前初始容量测试：对电池按照 3.10 的方法进行容量测试，记录初始容量 C_0 。

Cycle test: ambient temperature $25^\circ\text{C} \pm 2^\circ\text{C}$;

循环测试：环境温度 $25^\circ\text{C} \pm 2^\circ\text{C}$;

a. Charge the cell to 3.65 V with constant current of 0.5C, and then charge at constant voltage of 3.65 V until the current decreases to 0.05C and rest for 30 min;

b. Discharge to 2.5 V with constant current of 0.5C and rest for 30 min;

c. 4000 cycles according to steps a~b.

a. 对电池以 0.5C 的电流恒流充电至 3.65 V 后转恒压充电至 0.05C 截止，搁置 30 min；

b. 以 0.5C 的电流恒流放电至 2.5 V，搁置 30 min；

c. 重复 a ~ b 循环 4000 次。

Capacity test after cycle: discharge the cell to 2.5 V with constant current of 0.5C at ambient temperature of $25^\circ\text{C} \pm 2^\circ\text{C}$. Rest for 30 min, then charging it to 3.65 V with constant current of 0.5C, and switch to constant voltage charging until the cut-off current is 0.05C. Rest for 30 min, then discharging to 2.5 V with constant current of 0.5C, and record the discharge capacity C_{14} . The capacity retention rate = $C_{14} / C_0 \times 100\%$.

循环后容量测试：在 $25^\circ\text{C} \pm 2^\circ\text{C}$ 的环境下对电池以 0.5C 电流恒流放电至 2.5 V，搁置 30 min，然后以 0.5C 电流恒流充电至 3.65 V 后，转恒压充电至充电电流为 0.05C 截止，搁置 30 min，最后 0.5C 放电至 2.5 V，记录放电容量 C_{14} ，容量保持率= $C_{14} / C_0 \times 100\%$ 。

3.15.2 45°C 0.5C / 0.5C Cycle 45°C 0.5C / 0.5C 循环

Before the test, prepare and install the clamp according to 3.3.1.

Model 型号	LF304	Specification No. 规格书编号	PBRI-LF304-D06-01	Version 版本	E
-------------	-------	----------------------------	-------------------	---------------	---

测试前按照 3.3.1 进行夹具准备和安装。

Initial capacity test before cycling: test the cell capacity according to (3.10). and record the initial capacity as C_0 .

循环前初始容量测试：对电池按照 3.10 的方法进行容量测试，记录初始容量 C_0 。

Cycle test: ambient temperature $45^\circ\text{C} \pm 2^\circ\text{C}$;

循环测试：环境温度 $45^\circ\text{C} \pm 2^\circ\text{C}$;

a. Charge the cell to 3.65 V with constant current of 0.5C, then switching to constant voltage charging until the cut-off current is 0.05C, and rest for 30 min;

b. Discharge to 2.5 V with constant current of 0.5C and rest for 30 min;

c. 2000 cycles according to steps a~b.

a. 对电池以 0.5C 的电流恒流充电至 3.65 V 后转恒压充电至 0.05C 截止，搁置 30 min；

b. 以 0.5C 的电流恒流放电至 2.5 V，搁置 30 min；

c. 重复 a ~ b 循环 2000 次。

Capacity test after cycle: discharge the cell to 2.5 V with constant current of 0.5C at ambient temperature of $25^\circ\text{C} \pm 2^\circ\text{C}$. Rest for 30 min, then charging it to 3.65 V with constant current of 0.5C, and switch to constant voltage charging until the cut-off current is 0.05C. Rest for 30 min, then discharging to 2.5 V with constant current of 0.5C, and record the discharge capacity C_{15} . The capacity retention rate = $C_{15} / 304 \times 100\%$.

循环后容量测试：在 $25^\circ\text{C} \pm 2^\circ\text{C}$ 的环境温度下对电池以 0.5C 电流恒流放电至 2.5 V，搁置 30 min，然后以 0.5C 电流恒流充电至 3.65 V 后，转恒压充电至充电电流为 0.05C 截止，搁置 30 min，最后 0.5C 放电至 2.5 V，记录放电容量 C_{15} ，容量保持率= $C_{15} / 304 \times 100\%$ 。

3.15.3 Recommend EVE Cycling Method EVE 推荐循环方式

Before the test, prepare and install the clamp according to 3.3.1.

测试前按照 3.3.1 进行夹具准备和安装。

Initial capacity test before cycling: test the cell capacity according to (3.10). and record the initial capacity as C_0 .

循环前初始容量测试：对电池按照 3.10 的方法进行容量测试，记录初始容量 C_0 。

3.15.3.1 Steps of 25 °C Staged Charging Cycle 25 °C 阶梯充电循环工步：

a. Ambient temperature at $25^\circ\text{C} \pm 2^\circ\text{C}$;

b. With 1C constant current charging capacity as 80% C_0 ;

c. 0.8C constant current charging to 3.5 V;

d. 0.5C constant current charging to 3.6 V;

e. 0.1C constant current charging to 3.65 V;

f. Rest for 30 min in an open circuit state, discharge to 2.5 V with constant current of 1C, and rest for 30 min;

g. Repeat steps from b to f. When the cycle capacity retention rate decreases by 5%, the current value of 1C is

Model 型号	LF304	Specification No. 规格书编号	PBRI-LF304-D06-01	Version 版本	E
-------------	-------	----------------------------	-------------------	---------------	---

adjusted to $1C \times (1 - 5\% \times n)$, $n=1, 2, 3, 4, \dots$; ensure the charging time remains the same every 5% decay, and the specific steps are shown in the corresponding charging and discharging ammeter of the staged charging cycle;

- h. 4000 cycles according to steps b~g.
- a. 环境温度 $25^{\circ}\text{C} \pm 2^{\circ}\text{C}$;
- b. 1C 恒流充电至 80% C_0 ;
- c. 0.8C 恒流充电至 3.5 V;
- d. 0.5C 恒流充电至 3.6 V;
- e. 0.1C 恒流充电至 3.65 V;
- f. 在开路状态静置30 min, 以1C恒流放电至2.5 V, 搁置30 min;
- g. 重复 b 到 f 步骤, 循环容量保持率每衰减 5%时, 此时 1C 电流值调整为 $1C \times (1 - 5\% \times n)$, $n=1, 2, 3, 4, \dots$; 确保每衰减 5%的充电时长保持一致, 具体步骤见阶梯充电循环对应充放电电流表;
- h. 按步骤 b ~ g 循环 4000 次。

3.15.3.2 Steps of 45 °C Staged Charging Cycle 45 °C 阶梯充电循环工步:

- a. Ambient temperature $45^{\circ}\text{C} \pm 2^{\circ}\text{C}$;
- b. With 1C constant current charging capacity as 80% C_0 ;
- c. 0.8C constant current charging to 3.5 V;
- d. 0.5C constant current charging to 3.6 V;
- e. 0.1C constant current charging to 3.65 V;
- f. Rest for 30 min in an open circuit state, discharge to 2.5 V with constant current of 1C, and rest for 30 min;
- g. Repeat steps from b to f. When the cycle capacity retention rate decreases by 5%, the current value of 1C is adjusted to $1C \times (1 - 5\% \times n)$, $n=1, 2, 3, 4, \dots$; ensure the charging time remains the same every 5% decay, and the specific steps are shown in the corresponding charging and discharging ammeter of the staged charging cycle;
- h. 2000 cycles according to steps b~g.
- a. 环境温度 $45^{\circ}\text{C} \pm 2^{\circ}\text{C}$;
- b. 1C 恒流充电至 80% C_0 ;
- c. 0.8C 恒流充电至 3.5 V;
- d. 0.5C 恒流充电至 3.6 V;
- e. 0.1C 恒流充电至 3.65 V;
- f. 在开路状态静置30 min, 以1C恒流放电至2.5 V, 搁置30 min;
- g. 重复 b 到 f 步骤, 循环容量保持率每衰减 5%时, 此时 1C 电流值调整为 $1C \times (1 - 5\% \times n)$, $n=1, 2, 3, 4, \dots$; 确保每衰减 5%的充电时长保持一致, 具体步骤见阶梯充电循环对应充放电电流表;
- h. 按步骤 b ~ g 循环 2000 次。

Corresponding Charging Current Table for Staged Charging Cycle:

Model 型号	LF304	Specification No. 规格书编号	PBRI-LF304-D06-01	Version 版本	E
-------------	-------	----------------------------	-------------------	---------------	---

阶梯充电循环对应充电电流表:

Table 5 Corresponding charging current meter for stepped charging cycle

表 5 阶梯充电循环对应充电电流表

Items 项目	Current/Capacity 电流/容量	Current capacity / calibrated capacity × 100% (SOH) 当前容量 / 标定容量 × 100% (SOH)			
		> 95%	[95% ~ 90%)	[90% ~ 85%)	[85% ~ 80%)
Charging Current (A) 充电电流 (A)	1C	250	250	250	250
	0.8C	243.2	231.04	218.88	206.72
	0.5C	152	144.4	136.8	129.2
	0.1C	30.4	28.88	27.36	25.84
Discharging Current (A) 放电电流 (A)	1C	304.0	304.0	304.0	304.0
1C constant Current Charge to 80% C ₀ ; 1C 恒流充电至容量 80% C ₀		80% C ₀	76% C ₀	72% C ₀	68% C ₀

Remarks:

1. When the cycle capacity retention rate decreases by 5%, the charging current 1C / 0.8C / 0.5C / 0.1C current value is adjusted to $1C / 0.8C / 0.5C / 0.1C \times (1 - 5\% \times n)$ at this time, $n=0, 1, 2, 3, 4, \dots$; set the current according to the charging and discharging ammeter corresponding to the stepped charging.

2. When the charging current is greater than or equal to 250 A, 250 A shall prevail; When the charging current is less than 250 A, the actual current shall prevail.

备注:

1. 循环容量保持率每衰减 5% 时, 此时充电电流 1C / 0.8C / 0.5C / 0.1C 电流值调整为 $1C / 0.8C / 0.5C / 0.1C \times (1 - 5\% \times n)$, $n=0, 1, 2, 3, 4, \dots$; 按阶梯充电对应充放电电流表设置电流。

2. 当充电电流大于等于 250 A, 以 250 A 为准; 当充电电流小于 250 A 时, 以实际电流为准。

3.16 Swelling Force Test 膨胀力测试

Prepare and install the clamp according to 3.3.2. before the test.

测试前按照 3.3.2 进行夹具准备和安装。

Cycle according to (3.15.3.1) and record cell swelling force during test process.

按照 (3.15.3.1) 进行循环, 记录每圈充放电过程中的电池最大膨胀力和放电容量保持率。

3.17 Safety Performance 安全性能

3.17.1 Overdischarge 过放电

Charge the cell to 3.65 V with constant current of 1C at ambient temperature of $22^{\circ}\text{C} \pm 5^{\circ}\text{C}$, and then switch to

Model 型号	LF304	Specification No. 规格书编号	PBRI-LF304-D06-01	Version 版本	E
-------------	-------	----------------------------	-------------------	---------------	---

constant voltage charging at 3.65 V until the charging current decreases to 0.05C. Discharge the cell with constant current of 1C for 90 min at 22°C ± 5°C of safety test. Observe for 1 h. (Refer to GB 38031-2020 electric vehicles traction cell safety requirements)

在环境温度 22°C ± 5°C 条件下，对电池以 1C 电流恒流充电至 3.65 V，在 3.65 V 下转恒压充电，至 0.05C 截止。在安全试验环境温度 22°C ± 5°C 下电池以 1C 恒流放电 90 min。观察 1 h。（参考 GB 38031-2020 电动汽车用动力蓄电池安全要求）

3.17.2 Overcharge 过充电

Charge the cell to 3.65 V with constant current of 1C at ambient temperature of 22°C ± 5°C, and switch to constant voltage charging at 3.65 V until the charging current reaches 0.05C, then installing the test clamp according to 3.3.1. After charge the cell to 1.1 times of the termination voltage, or 115% SOC with constant current of not less than 1 / 3C at the safety test ambient temperature of 22°C ± 5°C, stop charging. Observe for 1 h. (Refer to GB 38031-2020 electric vehicles traction cell safety requirements)

在环境温度 22°C ± 5°C 条件下，对电池以 1C 电流恒流充电至 3.65 V，在 3.65 V 下转恒压充电，至 0.05C 截止，然后按照 3.3.1 的方法安装测试夹具。在安全试验环境温度 22°C ± 5°C 下电池以不小于 1 / 3C 恒流充电至终止电压的 1.1 倍或 115% SOC 后，停止充电。观察 1 h。（参考 GB 38031-2020 电动汽车用动力蓄电池安全要求）

3.17.3 External Short-circuit 外部短路

Charge the cell to 3.65 V with constant current of 1C at ambient temperature of 22°C ± 5°C, and then switch to constant voltage charging at 3.65 V until the charging current reaches 0.05C. The positive and negative terminals of the cell are short-circuited externally for 10 min under the safety test ambient temperature of 22°C ± 5°C, and the resistance of the external circuit should be less than 5 mΩ. Observe for 1 h. (Refer to GB 38031-2020 electric vehicles traction cell safety requirements)

在环境温度 22°C ± 5°C 条件下，对电池以 1C 电流恒流充电至 3.65 V，在 3.65 V 下转恒压充电，至 0.05C 截止。在安全试验环境温度 22°C ± 5°C 下将电池正、负极经外部短路 10 min，外部线路电阻值应小于 5 mΩ。观察 1 h。（参考 GB 38031-2020 电动汽车用动力蓄电池安全要求）

3.17.4 Heating 加热 (130°C)

Charge the cell to 3.65 V with constant current of 1C at ambient temperature of 22°C ± 5°C, and then switch to constant voltage charging at 3.65 V until the charging current reaches 0.05C. Put the cell into the temperature chamber, and the temperature chamber will rise from room temperature to 130°C ± 2°C at a rate of 5 °C/min, and keep this temperature for 30 min before stop heating. Observe for 1 h. (Refer to GB 38031-2020 electric vehicles traction cell safety requirements)

在环境温度 22°C ± 5°C 条件下，对电池以 1C 电流恒流充电至 3.65 V，在 3.65 V 下转恒压充电，至 0.05C 截

Model 型号	LF304	Specification No. 规格书编号	PBRI-LF304-D06-01	Version 版本	E
-------------	-------	----------------------------	-------------------	---------------	---

止。将电池放入温度箱，温度箱按照 5 °C/min 的速率由室温升至 130°C ±2°C，并保持此温度 30 min 后停止加热。观察 1 h。（参考 GB 38031-2020 电动汽车用动力蓄电池安全要求）

3.17.5 Temperature Cycling 温度循环

Charge the cell to 3.65 V with constant current of 1C at ambient temperature of 22°C ± 5°C, and then switch to constant voltage charging at 3.65 V until the charging current reaches 0.05C. Put the cell into the temperature chamber, and adjust the temperature chamber according to the following table and figure, and cycle for 5 times. (Refer to GB 38031-2020 electric vehicles traction cell safety requirements)

在环境温度 22°C ±5°C 条件下，对电池以 1C 电流恒流充电至 3.65 V，在 3.65 V 下转恒压充电，至 0.05C 截止。将电池放入温度箱中，温度箱按照下表进行调节，循环次数 5 次。（参考 GB 38031-2020 电动汽车用动力蓄电池安全要求）

Table 6 Temperature cycle corresponding parameter table

表 6 温度循环对应参数

Temperature 温度 (°C)	Time Increment 时间增量 (min)	Time Accumulation 累计时间 (min)	Temperature Change Rate 温度变化率 (°C/min)
25	0	0	0
-40	60	60	13/12
-40	90	150	0
25	60	210	13/12
85	90	300	2/3
85	110	410	0
25	70	480	6/7

3.17.6 Crush 挤压

Charge the cell to 3.65 V with constant current of 1C at ambient temperature of 22°C ± 5°C, and then switch to constant voltage charging at 3.65 V until the charging current reaches 0.05C. Test under the following conditions at a safety test environment temperature of 22°C ±5°C:

a) Crushing direction: apply pressure perpendicular to the direction of the cell plate, or the same direction that the cell is most susceptible to to be crushed in the layout of the whole vehicle;

b) The form of the crushing plate: a semi-cylinder with a radius of 75 mm, the length (L) of the semi-cylinder is greater than the size of the cell being crushed (refer to the figure below);

c) Crushing speed: not more than 2 mm/s;

d) Crushing degree: stop crushing after the voltage reaches 0 V or the deformation reaches 15% or the extruding

Model 型号	LF304	Specification No. 规格书编号	PBRI-LF304-D06-01	Version 版本	E
-------------	-------	----------------------------	-------------------	---------------	---

force reaches 100000 N or 1000 times the weight of the test object;

e) Keep it for 10 min. Observe for 1 h. (Refer to GB 38031-2020 electric vehicles traction cell safety requirements)

在环境温度 $22^{\circ}\text{C} \pm 5^{\circ}\text{C}$ 的条件下，对电池以 1C 电流恒流充电至 3.65 V，在 3.65 V 下转恒压充电，至 0.05C 截止。在安全试验环境温度 $22^{\circ}\text{C} \pm 5^{\circ}\text{C}$ 下按照如下条件进行试验：

- a) 挤压方向：垂直于电池单体极板方向施压，或与电池单体在整车布局上最容易受到挤压的方向相同；
- b) 挤压板形式：半径 75 mm 的半圆柱体，半圆柱体的长度 (L) 大于被挤压电池单体的尺寸；
- c) 挤压速度：不大于 2 mm/s；
- d) 挤压程度：电压达到 0 V 或变形量达到 15% 或挤压力达到 100000 N 或 1000 倍试验对象重量后停止挤压；
- e) 保持 10 min。观察 1 h。（参考 GB 38031-2020 电动汽车用动力蓄电池安全要求）

4 Cell Application Instructions 电池使用说明

4.1 Welding Parameters Recommendation 焊接参数建议

Table 7 Parameters Table

表 7 焊接参数表

Items 项目	Specifications 规格	Notes 备注
Laser Welding Depth 激光焊接熔深	$\leq 2.0 \text{ mm}$	/
Welding Parameter of Al Busbar 铝巴焊接参数	Max Pressure Force on Poles 极柱承受最大压力	700 N Max force in longitudinal direction, no deformation. 极柱承受最大垂直力，不发生变形
	Max Torque Force on Poles 极柱承受最大扭矩	6 N m Max torsion, non-loosen. 极柱承受最大扭曲，不松动
	Max Temperature Force on Poles 极柱承受最大温度	130°C The maximum temperature that the pole bears before the plastic pad deforms. 极柱承受最大温度，塑胶垫不发生变形

4.2 Charge and Discharge Parameters 充放电参数

The following data is the reference performance data of LF304 Cell during BMS design. Actual use is subject to the using mode and conditions agreed by both parties.

以下数据为 LF304 电池参考性能数据，供 BMS 设计时参考，实际使用以双方约定的使用方式和条件为准。

4.2.1 Charging Mode 充电模式

Table 8 Charging mode parameter table

表 8 充电模式参数表

Model 型号	LF304	Specification No. 规格书编号	PBRI-LF304-D06-01	Version 版本	E
Parameters 参数		Product Specifications 产品规格		Notes 备注	
Standard Charging Current 标准充电电流		0.5C		25°C ± 2°C	
Maximum Continuous Charging Current 最大持续充电电流		1C			
Standard Charging Cut-off Voltage 标准充电截止电压		Single cell ≤ 3.65 V 单体电池 ≤ 3.65 V			
Standard Charging Mode 标准充电模式		Refer to section 3.8 参考 3.8 节			
Standard Charging Temperature 标准充电温度		25°C ± 2°C			
Absolute Charging Temperature (Cell Temperature) 绝对充电温度 (电池温度)		-10°C ~ 65°C		No matter what charging mode the cell is in, once the cell temperature exceeds the absolute charging temperature range, stop charging. 无论电池处于何种充电模式, 电池温度一旦超出绝对充电温度范围, 即停止充电	
Absolute Charging Voltage 绝对充电电压		Max 3.65 V 最大 3.65 V		No matter what charging mode the cell is in, once the cell voltage exceeds the absolute charging voltage, stop charging. 无论电池处于何种充电模式, 电池电压一旦超出绝对充电电压, 即停止充电	

4.2.2 Other Charging Modes 其他充电模式

4.2.2.1 Continuous Charging Modes 持续充电模式

Table 9 Continuous charging modes / C-cell level (unit: C-Rate)

表 9 持续充电模式 / C-电池级别 (单位: C-Rate)

T / SOC	0%	10%	20%	30%	40%	50%	60%	70%	80%	90%	95%	98%	100%
-10°C	0	0	0	0	0	0	0	0	0	0	0	0	0
-5°C	0.15	0.15	0.15	0.15	0.12	0.12	0.08	0.08	0.07	0.05	0.05	0.05	0
0°C	0.3	0.3	0.3	0.25	0.12	0.12	0.1	0.1	0.08	0.08	0.05	0.05	0
5°C	0.45	0.45	0.35	0.35	0.25	0.25	0.19	0.16	0.13	0.12	0.12	0.12	0
10°C	0.7	0.68	0.65	0.56	0.5	0.5	0.37	0.37	0.37	0.37	0.12	0.12	0
25°C	1	1	1	1	1	1	1	1	1	0.8	0.5	0.5	0
45°C	1	1	1	1	1	1	1	1	1	0.8	0.5	0.5	0
55°C	0.5	0.5	0.5	0.5	0.5	0.5	0.5	0.5	0.5	0.5	0.4	0.4	0
60°C	0.28	0.28	0.28	0.28	0.28	0.28	0.28	0.28	0.28	0.28	0.28	0.28	0
65°C	0	0	0	0	0	0	0	0	0	0	0	0	0

Model 型号	LF304	Specification No. 规格书编号	PBRI-LF304-D06-01	Version 版本	E
-------------	-------	----------------------------	-------------------	---------------	---

4.2.2.2 Pulse Feedback Modes 脉冲回馈模式

Table 10 30 s pulse feedback rate / C-cell level (unit: C-Rate)

表 10 30 s 脉冲回馈倍率 / C-电池级别 (单位: C-Rate)

T\SOc	0%	5%	10%	20%	30%	40%	50%	60%	70%	80%	90%	95%	100%
-10°C	0	0	0	0	0	0	0	0	0	0	0	0	0
-5°C	0.4	0.4	0.4	0.4	0.3	0.3	0.3	0.2	0.2	0.2	0.1	0.1	0
0°C	0.6	0.6	0.5	0.5	0.4	0.4	0.4	0.4	0.3	0.3	0.2	0.2	0
10°C	0.8	0.8	0.8	0.8	0.8	0.8	0.8	0.8	0.8	0.8	0.4	0.25	0
20°C	1.6	1.6	1.6	1.6	1.6	1.6	1.6	1.6	1.6	1.6	0.8	0.4	0
25°C	2	2	2	2	2	2	2	2	2	2	1.6	0.8	0
30°C	2	2	2	2	2	2	2	2	2	2	1.6	0.8	0
35°C	2	2	2	2	2	2	2	2	2	2	1.6	0.8	0
45°C	2	2	2	2	2	2	2	2	2	2	1.6	0.8	0
50°C	2	2	2	2	2	2	2	2	2	2	1.6	0.8	0
55°C	1.6	1.6	1.6	1.6	1.6	1.6	1.6	1.6	1.6	1.6	1.2	0.8	0
60°C	0.28	0.28	0.28	0.28	0.28	0.28	0.28	0.28	0.28	0.28	0.28	0.28	0
65°C	0	0	0	0	0	0	0	0	0	0	0	0	0

Note: In order to ensure the safe use during the whole life cycle and maximize the service life of the cell, the charging power (rate) must be adjusted according to the SOH (capacity attenuation) of the cell. It should be ensured that the BMS has this function to monitor the actual charging power (and allowable charging power limit), and trigger fault and protection functions when necessary.

注：为确保全生命周期的使用安全并最大限度延长电池使用寿命，充电功率（倍率）必须要根据电池的 SOH（容量衰减）来进行调整。BMS 应确保具有该功能，并对实际的充电功率（和允许充电功率限制）做监测，并在必要的时候触发故障和保护功能。

4.2.3 Discharge Mode 放电模式

Model 型号	LF304	Specification No. 规格书编号	PBRI-LF304-D06-01	Version 版本	E
-------------	-------	----------------------------	-------------------	---------------	---

Table 11 Discharge mode parameter table

表 11 放电模式参数表

Parameters 参数	Product Specifications 产品规格	Notes 备注
Standard Discharge Current 标准放电电流	0.5C	25°C ±2°C
Maximum Continuous Discharge Current 最大持续放电电流	1C	
Discharge Cut-off Voltage 放电截止电压	2.5 V	Temperature T > 0°C 温度 T > 0°C
	2.0 V	Temperature T ≤ 0°C 温度 T ≤ 0°C
Standard Discharge Mode 标准放电模式	Refer to Section of 3.9 参考 3.9 节	
Standard Discharge Temperature 标准放电温度	25°C ±2°C	
Absolute Discharge Temperature (Cell Temperature) 绝对放电温度 (电池温度)	-35°C ~ 65°C	No matter what discharge mode the cell is in, once the cell temperature exceeds the absolute discharge temperature range, stop discharging. 无论电池处于何种放电模式，电池温度一旦超出绝对放电温度范围，即停止放电
Absolute Discharge Voltage 绝对放电电压	Min 2.5 V (T > 0°C) Min 2.0 V (T ≤ 0°C) 最小 2.5 V (T > 0°C) 最小 2.0 V (T ≤ 0°C)	No matter what kind of discharge mode the cell is in, once the cell voltage is less than the absolute discharge voltage, stop discharging. 无论电池处于何种放电模式，电池电压一旦小于绝对放电电压，即停止放电

4.2.4 Other Discharging Modes 其他放电模式

4.2.4.1 Continuous Discharging Modes 持续放电模式

Model 型号	LF304	Specification No. 规格书编号	PBRI-LF304-D06-01	Version 版本	E
-------------	-------	----------------------------	-------------------	---------------	---

Table 12 Continuous discharge rate / C-cell level (unit: C-Rate)

表 12 持续放电倍率 / C-电池级别 (单位: C-Rate)

T / SOC	0%	5%	10%	20%	30%	40%	50%	60%	70%	80%	90%	95%	100%
<35°C	0	0	0	0	0	0	0	0	0	0	0	0	0
-35°C	0	0	0	0.1	0.1	0.1	0.1	0.1	0.1	0.1	0.1	0.1	0.1
-30°C	0	0.03	0.06	0.12	0.25	0.25	0.25	0.25	0.25	0.25	0.25	0.25	0.25
-20°C	0	0.06	0.12	0.25	0.5	0.5	0.5	0.5	0.5	0.5	0.5	0.5	0.5
-10°C	0	0.19	0.38	0.5	0.5	0.5	0.5	0.5	0.5	0.5	0.5	0.5	0.5
0°C	0	0.28	0.56	1	1	1	1	1	1	1	1	1	1
25°C	0	0.38	0.75	1	1	1	1	1	1	1	1	1	1
60°C	0	0.38	0.75	1	1	1	1	1	1	1	1	1	1
65°C	0	0	0	0	0	0	0	0	0	0	0	0	0

4.2.4.2 Pulsing Discharging Modes 脉冲放电模式

Table 13 30 s pulse discharge rate / C-cell level (unit: C-Rate)

表 13 30 s 脉冲放电倍率 / C-电池级别 (单位: C-Rate)

T\SOC	0%	5%	10%	20%	30%	40%	50%	60%	70%	80%	90%	95%	100%
-36°C	0	0	0	0	0	0	0	0	0	0	0	0	0
-35°C	0	0	0	0	0.1	0.1	0.1	0.1	0.1	0.1	0.1	0.1	0.1
-30°C	0	0.03	0.06	0.12	0.25	0.25	0.25	0.25	0.25	0.25	0.25	0.25	0.25
-20°C	0	0.06	0.12	0.25	0.5	0.5	0.5	0.5	0.5	0.5	0.5	0.5	0.5
-10°C	0	0.19	0.38	0.62	1.2	1.2	1.2	1.2	1.2	1.2	1.2	1.2	1.2
-5°C	0	0.25	0.5	1	2.12	2.12	2.12	2.12	2.12	2.12	2.12	2.12	2.12
0°C	0	0.28	0.56	1.06	2.18	2.18	2.18	2.18	2.18	2.18	2.18	2.18	2.18
5°C	0	0.31	0.62	1.12	2.25	2.25	2.25	2.25	2.25	2.25	2.25	2.25	2.25
10°C	0	0.33	0.66	1.22	2.43	2.43	2.43	2.43	2.43	2.43	2.43	2.43	2.43
15°C	0	0.34	0.68	1.32	2.63	2.63	2.63	2.63	2.63	2.63	2.63	2.63	2.63
20°C	0	0.36	0.72	1.41	2.82	2.82	2.82	2.82	2.82	2.82	2.82	2.82	2.82
25°C	0	0.38	0.75	1.5	3	3	3	3	3	3	3	3	3
45°C	0	0.38	0.75	1.5	3	3	3	3	3	3	3	3	3
60°C	0	0.38	0.75	1.5	3	3	3	3	3	3	3	3	3
65°C	0	0	0	0	0	0	0	0	0	0	0	0	0

Model 型号	LF304	Specification No. 规格书编号	PBRI-LF304-D06-01	Version 版本	E
-------------	-------	----------------------------	-------------------	---------------	---

4.3 Safety Limits 安全限制

4.3.1 Application Conditions 应用条件

Customer shall ensure strict compliance with the following cell application conditions:

客户应当确保严格遵守以下与电池相关的应用条件：

a) Customer shall configure a battery management and monitoring system to strictly monitor, manage and protect each cell. And a battery management archive shall be established to keep all monitoring data of the cells, so as to be a reference for problems tracing and product quality responsibility division. **EVE is not responsible for product quality assurance if no complete monitoring data of the battery system during its service life is provided.**

a) 客户应配置电池管理和监控系统，严密监控、管理与保护每个电池，并建立电池管理档案，保存完整的电池运转的监测数据，用做问题追溯及产品质量责任划分的参考。不具备完整的电池系统使用期限内的监测数据的，EVE 不承担产品质量保证责任

b) The waterproof and dustproof problems of the cell shall be fully considered in the design of the pack, and the pack must meet the waterproof and dustproof grade stipulated by relevant national standards. **EVE is not responsible for the damage (such as corrosion, rust, etc.) of the cell caused by waterproof and dustproof problems.**

b) 电池包设计中应充分考虑电池的防水、防尘问题，电池包必须满足国家有关标准规定的防水、防尘等级。由于防水、防尘问题而导致的电池或电池包的损坏（如腐蚀、生锈、等），EVE 不承担质量保证责任。

c) **It is forbidden to mix different types of cells in the same battery system (or vehicle), otherwise, EVE will not be responsible for the quality assurance.**

c) 禁止不同型号电池在同一电池系统（或整车）中混用，否则，EVE 不承担质量保证责任。

4.3.2 Voltage Limits 电压限制

Table 14 Safety limit voltage parameters

表 14 安全限制电压参数

Items 项目	Categories 类别	Parameters 参数	Protective Actions 保护动作
Charging Voltage 充电电压	Charging Ends 充电终止	3.65 V	When the cell voltage reaches 3.65 V, stop charging. 当电池电压达到 3.65 V 时终止充电。
	First Over-Charging Protection 第一级过充电保护	3.80 V	When the cell voltage reaches 3.8 V, stop charging. 当电池电压达到 3.8 V 时终止充电。
	Second Over-Charging Protection 第二级过充电保护	3.85 V	When the cell voltage reaches 3.85 V, stop charging and lock the battery management system until the technician solves the problem. 当电池电压达到 3.85 V 时终止充电，并锁定电池管理系统，直至技术人员解决问题。

Model 型号	LF304	Specification No. 规格书编号	PBRI-LF304-D06-01	Version 版本	E
Discharging Voltage 放电电压	Discharging Ends 放电终止	Min 2.50 V 最小 2.50 V	Temperature $T > 0^{\circ}\text{C}$. When the cell voltage reaches 2.5 V, stop discharging. 温度 $T > 0^{\circ}\text{C}$, 当电池电压达到 2.5 V, 终止放电。		
		Min 2.00 V 最小 2.00 V	Temperature $T \leq 0^{\circ}\text{C}$. When the cell voltage reaches 2.0 V, stop discharging. 温度 $T \leq 0^{\circ}\text{C}$, 当电池电压达到 2.0 V, 终止放电。		
	First Over-Discharging Protection 第一级过放电保护	Min 2.00 V 最小 2.00 V	Temperature $T > 0^{\circ}\text{C}$. When the cell voltage reaches 2.0 V, reduce the current to the minimum. 温度 $T > 0^{\circ}\text{C}$, 当电池电压达到 2.0 V, 将电流降到最小。		
		Min 1.90 V 最小 1.90 V	Temperature $T \leq 0^{\circ}\text{C}$. When the cell voltage reaches 1.9 V, reduce the current to the minimum. 温度 $T \leq 0^{\circ}\text{C}$, 当电池电压达到 1.9 V, 将电流降到最小。		
	Second Over-Discharging Protection 第二级过放电保护	Min 1.85 V 最小 1.85 V	Temperature $T > 0^{\circ}\text{C}$. When the cell voltage is lower than 1.85 V, stop charging and lock the battery management system until the technician solves the problem. 温度 $T > 0^{\circ}\text{C}$, 当电池电压低于 1.85 V 时, 锁定电池管理系统, 直至技术人员解决问题。		
		Min 1.75 V 最小 1.75 V	Temperature $T \leq 0^{\circ}\text{C}$. When the cell voltage is lower than 1.75 V, stop charging and lock the battery management system until the technician solves the problem. 温度 $T \leq 0^{\circ}\text{C}$, 当电池电压低于 1.75 V 时, 锁定电池管理系统, 直至技术人员解决问题。		
BMS protection BMS 保护	Short Circuit protection 短路保护	Short circuit is not allowed 不允许短路	When a short circuit occurs, the cell is disconnected by the overcurrent device. 发生短路时, 由过流器断开电池。		
	Long Charging Time Protection 充电时间过长保护	Charging time within 8 h 充电时间在 8 小时内	If the charging time is longer than 8 h, the charging will be terminated. 充电时间长于 8 小时, 则终止充电。		

Notes 备注:

a) If the cell charging voltage exceeds the cut-off voltage, corresponding protective actions need to be taken.

EVE shall not be responsible for any cell quality issues caused by exceeding the protection voltage.

a) 电池充电超过终止电压时, 需依据相应的保护动作采取措施, 对于超出保护电压带来的电池质量问题, EVE 不承担任何责任。

Model 型号	LF304	Specification No. 规格书编号	PBRI-LF304-D06-01	Version 版本	E
-------------	-------	----------------------------	-------------------	---------------	---

b) If the cell discharging voltage reaches the cut-off voltage, it is necessary to charge as soon as possible to prevent the cell from being overdischarged. EVE shall not be responsible for any cell quality issues caused by overdischarge.

b) 当电池放电电压到达终止电压时，需尽快充电，防止电池进入过放状态。因电池过放导致的电池质量问题，EVE 不承担任何保证责任。

4.3.3 Temperature Limits 温度限制

Table 15 Safety limit temperature parameters

表 15 安全限制温度参数

Items 项目	Parameters 参数	Notes 备注
Recommended Operating Temperature Range 推荐操作温度范围	10°C ~ 35°C	Recommend cell usage temperature range. 推荐使用电池的温度范围。
Maximum Operating Temperature 最高操作温度	65°C	If the cell temperature exceeds the maximum operating temperature, the power needs to be reduced to 0. 如果电池使用温度超过最高操作温度，功率需要降为 0。
Minimum Operating Temperature 最低操作温度	-35°C	If the cell temperature exceeds the minimum operating temperature, the power needs to be reduced to 0. 如果电池使用温度超过最低操作温度，功率需要降为 0。
Maximum Safe Temperature 最高安全温度	65°C	If the cell temperature exceeds the maximum safe temperature, irreversible and permanent damage will be caused. The user should not use it under environments higher than the maximum safe temperature. 如果电池使用温度超过最高安全温度，将会造成电池不可逆的永久性损坏，用户使用不得高于最高安全温度。
Minimum Safe Temperature 最低安全温度	-35°C	If the cell temperature exceeds the minimum safe temperature, irreversible and permanent damage will be caused. The user should not use it under environments lower than the minimum safe temperature. 如果电池使用温度超过最低安全温度，将会造成电池不可逆的永久性损坏，用户使用不得低于最低安全温度。

Notes 备注：

a) Prohibit charging the cell at low temperature (below -10°C) and the minimum safety temperature specified by this specification, otherwise EVE will not be responsible for any quality assurance liability.

Model 型号	LF304	Specification No. 规格书编号	PBRI-LF304-D06-01	Version 版本	E
-------------	-------	----------------------------	-------------------	---------------	---

a) 电池禁止在低温下 (-10°C以下) 充电及在规定的最低安全温度下放电, 否则 EVE 不承担任何电池质量保证责任。

b) **The heat dissipation design of battery may effect cell electrical performance, EVE will not be responsible for any assurance liability regarding cell quality issues caused by the heat dissipation design.**

b) 电池包的散热设计会影响电池性能, 因电池包散热设计问题导致的电池质量问题, EVE 不承担任何责任。

4.4 Parameters Recommendation for Module Design 模组设计参数建议

4.4.1 Cell Directions 电池方向

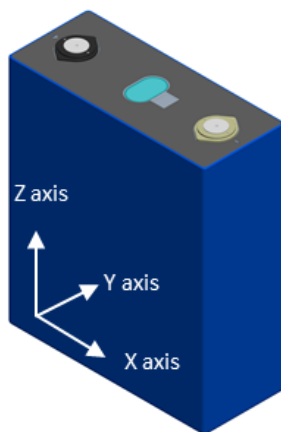

Fig.6 Diagram of LF304 Cell direction

图 6 LF304 电池方向示意图

4.4.2 Cell Compression Force 电池压缩力

When forming modules, a compression force in the direction of vertical thickness is applied to the cells in order to make them better arranged and fixed. If the compression force is too large, the cells may be damaged or even leak. Cell compression force test conditions are as follows:

电池在模组成组时, 为了使电池更好的排列固定, 对电池施加一个垂直厚度方向的压缩力, 压缩力过大, 电池内部可能收到损伤, 甚至漏液。电池压缩力测试条件如下:

-Compression area 压缩面积: 173.7 mm × 204.4 mm (L × H2)

-Compression speed 压缩速度: 0.02 mm/s

-Compression direction 压缩方向: Y direction Y 方向

-Cell SOC 电池 SOC: 15%~40 %

Model 型号	LF304	Specification No. 规格书编号	PBRI-LF304-D06-01	Version 版本	E
-------------	-------	----------------------------	-------------------	---------------	---

Table 16 Cell compression force limit parameters

表 16 电池压缩力限制参数

Observation 现象	Compression Force 压缩力
Recommend Compression Force 推荐压缩力	3000 N ~ 7000N
Instantaneous Maximum Compression Force 瞬时最大压缩力	10000 N

The compression force of the cell shall be no larger than 10 kN, otherwise the cell may be damaged.
 电池承受的压缩力不能超过 10000 N，否则电池可能会受到损害。

4.4.3 Cell Swelling force 电池膨胀力

The inherent characteristics such as the rebound of the electrode thickness may lead to cell expansion during use which generates force on the clamp., and the force increases with the attenuation of the cell capacity. The cell swelling force at BOL and EOL (80%SOH) is shown below:

在使用过程中，因极片厚度反弹等固有特性导致电池膨胀，而对约束夹具产生的作用力；电池的膨胀力随着电池容量的衰减而增加，电池 BOL 和 EOL（80%SOH）膨胀力如下表：

Table 17 Cell Swelling force parameters

表 17 电池膨胀力参数

Swelling force 膨胀力	BOL	≤ 3000 N
	EOL (80%SOH)	≤ 30000 N

Customer shall fully consider the influence of the cell Swelling force when designing the module.
 客户在设计模组时，应充分考虑电池膨胀力的影响。

4.4.4 Recommend Temperature Collection Points 推荐温度采集点

The recommended temperature collection points are the poles or code when collecting temperature of the cell surface.

对电池表面进行温度采集时，建议温度采集点布置在极柱或刻码处。

4.5 Thermodynamic Parameters 热力学参数

Test method: 测试方法：

Reference standards: GB/T 10295-2008、ASTM E1269-2011

Model 型号	LF304	Specification No. 规格书编号	PBRI-LF304-D06-01	Version 版本	E
-------------	-------	----------------------------	-------------------	---------------	---

参考标准：GB/T 10295-2008、ASTM E1269-2011

Table 18 Cell thermal conductivity parameter

表 18 电池导热系数参数

Mean Thermal Conductivity 导热系数均值	Thermal Conductivity W/(m K) 导热系数 W/(m K)	
	X/Z Direction X/Z 方向	Y Direction Y 方向
	10~15 W/(m K)	1~3 W/(m K)
Mean Heat Capacity 热容均值	Heat Capacity kJ/(kg K) 热容 kJ/(kg K)	
	0.9~1.2 kJ/(kg K)	

5 Precautions 注意事项

5.1 Product End-life Management 产品寿命终止管理

The cell life is limited. Customers should establish an effective tracking system to monitor and record the internal resistance and capacity of each cell during its life. The measurement method and calculation method of internal resistance and capacity need to be discussed and agreed between the customer and EVE. When the internal resistance of the cell in use exceeds 150% of the initial internal resistance of the cell, or the capacity is less than 70% of the nominal capacity, the cell should not to be operated. **Violation of this requirement will exempt EVE from its responsibility for product quality assurance in accordance with the product sales agreement and this specification, as well as all related liabilities such as loss compensation caused thereby.**

电池使用期限是有限的，客户应建立有效的跟踪系统监测并记录每个使用期限内电池的内阻和容量。内阻及容量的测量方法和计算方法需要客户和 EVE 共同讨论和双方同意。当使用中电池的内阻超过这个电池最初内阻的 150% 或容量小于标称容量的 70%，应停止使用电池。违反该项要求，将免除 EVE 依据产品销售协议以及本规格书所应承担的产品质量保证责任及由此引起的损失赔偿等一切相关责任。

5.2 Long-term Storage 长期存储

After charging, the cell should be used as soon as possible to avoid loss of usable capacity due to self-discharge. If long-term storage is required, adjust the cell SOC to 15%~40%. The recommended storage conditions are: 0°C ~ 35°C, relative humidity ≤ 60%.

Model 型号	LF304	Specification No. 规格书编号	PBRI-LF304-D06-01	Version 版本	E
-------------	-------	----------------------------	-------------------	---------------	---

电池进行充电后,需尽快使用,以免因自放电而造成可用容量损失。若需要存储,应将SOC调整为15%~40% SOC。推荐的存储条件为:0°C~35°C,相对湿度≤60%。

The state of charge (SOC, capacity state) of the cell should be kept at 15% ~ 40% during storage. In order to prevent the performance differences after long-term storage (more than three months), perform a standard charge-discharge cycle every 3 months. It is recommended that the storage time after receiving the cells should not exceed half a year to avoid quality problems due to storage overdue.

电池单体贮存时,荷电态(SOC,容量状态)应保持在15%~40%,长期贮存(三个月以上)时为防止电池性能差异,应每3个月进行一次标准充放电循环;建议收到货后储存时间不超过半年,避免存储超期造成的质量问题。

5.3 Transportation and Handling Requirements 运输及装卸要求

- It is not allowed to ship with inflammable, explosive and corrosive articles in the same vehicle during transportation, and stacking is prohibited during large package transportation; The product shall not be exposed to rain, snow and other liquid substances without any protection, or suffer mechanical damage;
- 在运输过程中不允许和易燃、易爆、易腐蚀的物品同车装运,大包装运输过程中禁止堆叠;产品不允许经受雨、雪或液体物质的淋袭与机械损伤;
- While handling, lift trucks or special tools shall be used to load and unload products; Handle with care, do not throw or squeeze, which may cause cell damage or personal injury. It is strictly prohibited to put cells together with corrosive substances such as acid and alkali.
- 产品装卸时,须采用升降车或专用工具对产品进行上下车;要轻取轻放,不得扔掷、挤压,造成电池损坏或对人身体的意外伤害,严禁与酸碱等腐蚀物品放在一起。

5.4 Operation Precautions 操作说明

- It is strictly forbidden to immerse the cell in water. When it is not in use, it should be placed in a cool and dry environment.
- 严禁将电池浸入水中,保存不用时,应放置于阴凉干燥的环境中。
- Do not over-charge the cell. Otherwise, cell overheating and fire may occur. During cell installation and use, hardware and software must be protected against multiple over-charge failures. See 4.3 of this specification for the minimum requirements of protection.
- 禁止电池过充,否则,可能引起电池过热和火灾事故的发生。在电池安装和使用中,硬件和软件需实行多重过充失效安全保护。最低保护要求见本规格书4.3条。
- It's necessary to set a reasonable charging time limit, otherwise, the cell may overheat, resulting in thermal runaway or fire. BMS management failure of this kind shall be considered during module design.
- 应对电池持续充电时长进行合理限制。充电时间过长电池可能会出现过热现象,进而引起热失控和火灾。

Model 型号	LF304	Specification No. 规格书编号	PBRI-LF304-D06-01	Version 版本	E
-------------	-------	----------------------------	-------------------	---------------	---

在模组设计时需考虑此类 BMS 管理失效情况。

- If improper charge termination occurs, the root reasons shall be found and resolved before reuse to avoid negative effects on electrical and safety performances.
- 电池非正常终止充电时，为避免未知原因对电池性能及安全的影响，需明确根本原因并彻底解决后再使用。
- It is forbidden to over-discharge. During the normal use of the cell, charge the cell regularly to keep the voltage above 2.8 V, so as to avoid over-discharge.
- 禁止过放电。在电池正常使用过程中，为防止过放电，电池应定期充电，将电压维持在 2.8 V 以上。
- It is forbidden to use or place the cell at a high temperature environment. Otherwise, cell overheat, function failure or life shorten may occur.
- 禁止在高温下使用或放置电池，否则可能会引起电池过热或功能失效、寿命减短。
- The temperature of the cell shall not exceed 65°C in any normal use, otherwise the BMS must shut down the cell and stop cell operation.
- 在任何正常的使用情况下，电池温度不能超过 65°C，如果电池温度超过 65°C，电池管理系统需关闭电池，停止电池运行。
- Please use a special charger for lithium-ion batteries when charging.
- 充电时请选用锂离子电池专用充电器。
- During use, please connect the positive and the negative of the cell strictly according to the labels and instructions, and reverse charging is forbidden.
- 在使用过程中，严格按照标示和说明连接电池正负极，禁止反向充电。
- It is forbidden to use metal to directly connect the positive and the negative of the cell to short-circuit. Otherwise, strong current and high temperature may cause personal injury or fire.
- 禁止用金属直接连接电池正负极短路，否则强电流和高温可能导致人身伤害或者火灾。
- It is forbidden to transport or store the cell with metal, such as hairpins, necklaces, etc.
- 禁止将电池与金属，如发夹、项链等一起运输或贮存。
- It is forbidden to knock, throw, step on or bend the cell.
- 禁止敲击或抛掷、踩踏和弯折电池等。
- It is forbidden to directly weld the cell.
- 禁止直接焊接电池。
- It is forbidden to directly pierce the battery with nails or other sharp objects.
- 禁止用钉子或其它利器刺穿电池。
- Try to protect the cell from mechanical shock, collision and pressure impact. Otherwise, the cell may be short-circuited internally, resulting in high temperature and fire.

Model 型号	LF304	Specification No. 规格书编号	PBRI-LF304-D06-01	Version 版本	E
-------------	-------	----------------------------	-------------------	---------------	---

- 尽力保护电池，使其免受机械震动、碰撞及压力冲击，否则电池内部可能短路，产生高温和火灾。
- It is forbidden to use it in places with strong static electricity and strong magnetic fields; otherwise cell safety protection devices may be damaged and cause safety hazards.
- 禁止在强静电和强磁场的地方使用，否则易破坏电池安全保护装置，带来安全隐患。
- Customer shall securely fix the cell to a solid surface and bind the power cord in a proper place to avoid arcing and sparks caused by friction.
- 客户应将电池安全地固定在固体平面上，并将电源线安全地束缚在合适的位置，以避免摩擦而引起电弧和火花。
- It is forbidden to use plastic for cell encapsulation and electrical connection. Improper electrical connection may cause overheat during cell use.
- 严禁用塑料封装电池或用塑料进行电气连接。不正确的电气连接方式可能会造成电池使用过程中发生过热现象。
- If the cell leaks and the electrolyte spills onto the skin or clothes, immediately wash the affected area with running water. If the cell leaks and the electrolyte enters the eyes, mouth, nose and other open parts of the human body, immediately wash with plenty of water and seek medical treatment immediately, otherwise serious injuries will be caused to the human body. No person or animal is allowed to swallow any part of the cell or any substance contained in the cell.
- 如果电池漏液，电解液溅到皮肤或衣服上，应立即用流动的水清洗受影响区域，如果电池发生泄露，电解液进入眼睛、口、鼻等人体开放部位，应立即用大量清水冲洗，并马上送医治疗，否则会对人体造成严重伤害。禁止任何人或动物吞食电池的任何部位或电池所含物质。
- If the cell emits peculiar smell, heat, discoloration, deformation, or any abnormality during use, storage, or charging, immediately remove the cell from the device or charger and stop using it.
- 如果电池发出异味、发热、变色、变形或使用、贮存、充电过程中出现任何异常，立即将电池从装置或充电器中移离并停用。
- It is prohibited to disassemble the product without the written consent of EVE.
- 未经 EVE 书面同意，禁止私自拆解产品。

5.5 Confidentiality Agreement 保密协议

The customer shall keep the cooperation content highly confidential. Without the permission of EVE, the customer shall not disclose any content of the technical agreement to a third party. Otherwise, the customer will be held responsible according to relevant laws.

客户应对合作内容高度保密，未经 EVE 许可，不得向第三方透露规格书的任何内容，否则，将依照相关法律追究责任。

Model 型号	LF304	Specification No. 规格书编号	PBRI-LF304-D06-01	Version 版本	E
-------------	-------	----------------------------	-------------------	---------------	---

5.6 Risk Warning 风险警告

5.6.1 Warning Declaration 警示声明

Warning 警告

The cell has potential hazards, and take proper precautions when operating and maintaining the cell!

The cell must be operated with proper tools and protective equipment.

Cell maintenance must be performed by professional with cell expertise and safety training.

Failure to comply with these warnings could result in multiple disasters.

电池存在潜在的危險，在操作和维护时必须采取适当的防护措施！

必须使用正确的工具和防护装备操作电池。

电池的维护必须由具有电池专业知识并经过安全培训的人士执行。

不遵守上述警告可能造成多种灾难。

5.6.2 Types of Dangerous 危险类型

Customer must be aware of the following potential hazards in the use and operation of cells:

客户知悉在电池使用和操作过程中存在以下潜在的危險：

- a) There is a risk from electric shocks or electric arcs during operation.
- a) 存在受到电击或者电弧伤害的风险。
- b) There is a risk from the electrolyte or other chemicals.
- b) 存在受到电解液或其他化学品危害的风险。

Proper operation methods and protective equipment shall be selected to avoid short circuit, explosion or thermal runaway.

为防止发生意外短路，造成电弧、爆炸或热失控，需选择合适的操作方法及防护装备。

5.7. Disclaimer 免责声明

If the product demand party or user does not use the product in accordance with the provisions of this specification, EVE will no longer take any relevant responsibility such as product quality assurance liability and loss compensation caused thereby. In case of any negative impact on EVE's reputation due to the above-mentioned actions, EVE reserves the right to investigate the legal liability of the product demand party.

如果由于产品需求单位或使用者不按本说明书中的规定进行使用，EVE 不再承担产品质量保证责任及由此引起的损失赔偿等一切相关责任。因前述行为，对 EVE 的声誉造成负面影响的，EVE 保留追究产品需求单位法律责任权利。

Model 型号	LF304	Specification No. 规格书编号	PBRI-LF304-D06-01	Version 版本	E
-------------	-------	----------------------------	-------------------	---------------	---

6 Others 其他

6.1 Rights and Obligations of EVE EVE 的权利和义务

- EVE shall inspect according to the inspection standards in the protocol signed with the customer, and the products provided shall meet the requirements of various parameters in the protocol;
- EVE 按照与客户签订的协议中的检验标准进行检验，提供产品应符合协议中各项参数要求；
- EVE shall provide customer with stable and reliable products confirmed by both parties;
- EVE 向客户提供双方确认的、稳定可靠的产品；
- EVE is obliged to provide high-quality services for its products, and the service standards shall be in accordance with the standards promised by EVE;
- EVE 有义务为其产品提供优质的服务，服务标准按 EVE 所承诺的标准服务；
- EVE shall provide timely technical support and service in case of any problem or failure during the use and maintenance of system products by customer.
- 在客户对系统产品的使用及维护过程中遇到问题或故障时，EVE 进行及时的技术支持及服务。

6.2 Rights and Obligations of Customer 客户的权利和义务

- Customer must conduct production in strict accordance with the technical data provided by EVE, and strictly implement the cell prevention measures, safety limits and cell operation instructions in the technical data provided by EVE.
- 客户应严格按照 EVE 提供的技术资料进行生产，严格执行 EVE 所提供的技术资料中的电池防范措施、安全限制和电池操作说明。
- Customer has the obligation to ensure the safety of products by EVE and shall take corresponding fire prevention, waterproof and other measures.
- 客户有义务保证 EVE 产品的安全，应采取相应的防火、防水等措施。
- Customer has the obligation to make fair and detailed use records and monitoring data of product operation for EVE's products, which can be used as a reference for the division of product quality responsibilities. If there is no complete monitoring data within the service life of the battery system, EVE shall not be responsible for product quality assurance.
- 客户有义务对 EVE 的产品做出公平、公正详细的使用记录及产品运转的监测数据，用作于产品质量责任划分的参考，不具备完整的电池系统使用期限内的监测数据的，EVE 不承担产品质量保证责任。
- Customer has the obligation to notify EVE's personnel to be present and be informed of the actual situation when products of EVE operate abnormally.
- 客户有义务在 EVE 产品运作异常时，在可能的情况下通知 EVE 人员到场，了解实际情况。
- In the process of product manufacturing, customer shall take all corresponding responsibilities for the

Model 型号	LF304	Specification No. 规格书编号	PBRI-LF304-D06-01	Version 版本	E
-------------	-------	----------------------------	-------------------	---------------	---

problems or accidents caused by the operation in violation of the safety rules or the use beyond the conditions specified in this technical agreement and the combination of the product and the circuit (not the quality defects of the product itself).

- 客户在产品制造过程中，因违反安全守则操作、在本规格书说明条件之外使用及产品与电路等搭配（非产品自身质量缺陷）所产生的问题或事故，其责任与 EVE 无关，应由客户承担相应的责任。

Remarks: Any matter not mentioned in this specification must be negotiated and determined by both parties.

备注：任何本规格书中未提及的事项，须经双方协商确定。

6.3 Language Conflict Clause 语言冲突条款

This specification is written in both Chinese and English. In case of any difference between the Chinese version and the English version, the Chinese version shall prevail.

本规格书以中英双语书就，如中英文约定存在冲突时，以中文版本为准。

Model 型号	LF304	Specification No. 规格书编号	PBRI-LF304-D06-01	Version 版本	E
-------------	-------	----------------------------	-------------------	---------------	---

Appendix: Cell Drawing of LF304 附录：LF304 电池图纸

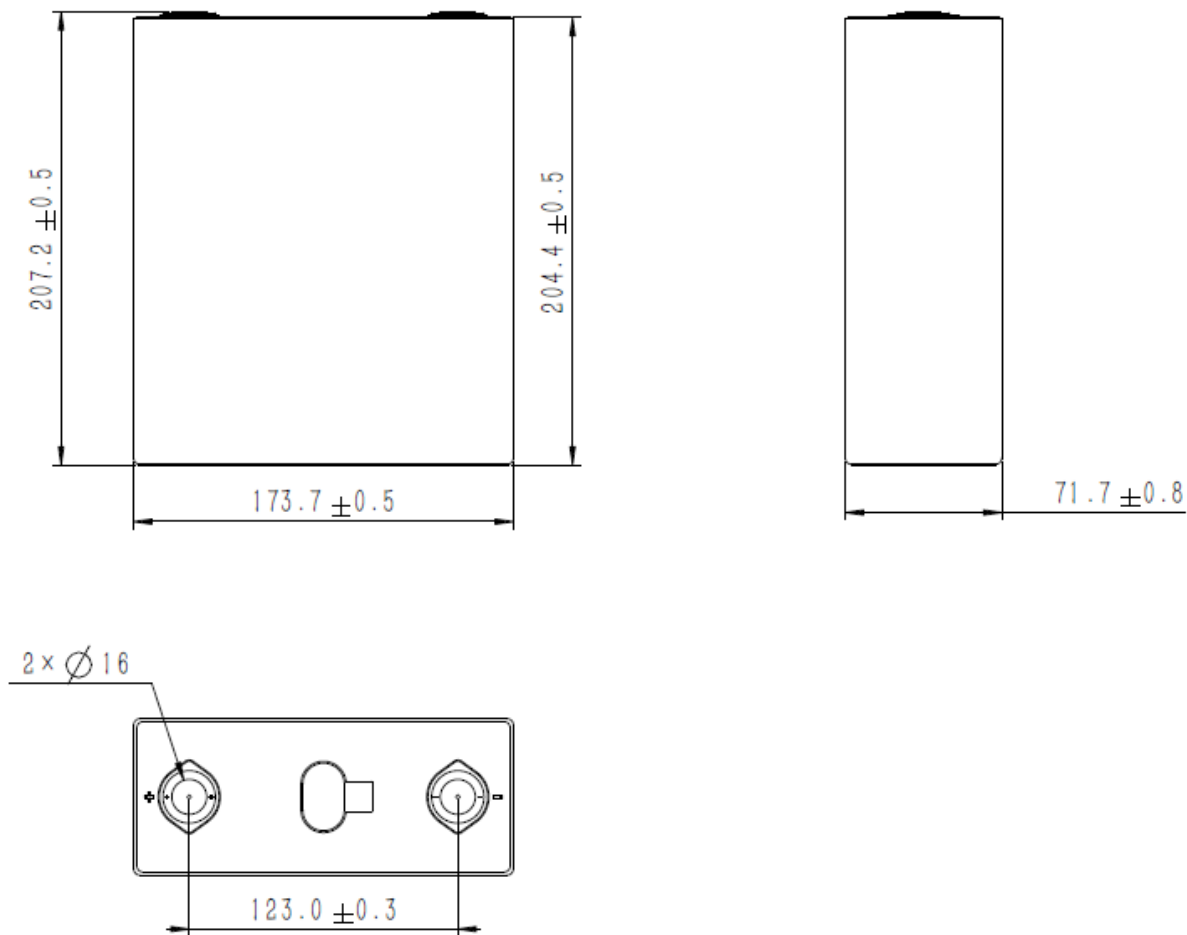

Fig.7 Diagram of Cell Size and Appearance

图 7 电池尺寸及外观图